

## NORTHERN LIGHTS SOLUTIONS



## 2017 GREEN ENERGY CHALLENGE PROPOSAL

SUBMISSION DATE: MAY 1, 2017

CECA/NECA  
UNIVERSITY OF TORONTO STUDENT CHAPTER



## Table of Contents

1	Project Summary .....	1
1.1	Executive Summary .....	1
	Mission Statement.....	1
	Team Members and Roles .....	1
1.2	The Client - Waterfront Neighbourhood Centre.....	2
1.3	Facility Description .....	3
1.4	Northern Lights Solutions - The Project Team .....	4
	Project Team Resumes.....	4
2	Technical Analysis 1: Energy Efficiency Analysis.....	11
2.1	Energy Audit Results .....	11
2.1.1	Lighting Summary.....	12
2.1.2	HVAC .....	12
2.1.3	Building Envelope .....	13
2.2	Energy Benchmark .....	14
2.2.1	EPA Portfolio Manager .....	14
2.2.2	DOE Building Asset Score.....	14
2.3	Proposed Improvements .....	15
2.3.1	Recommendation 1: Lighting Retrofit .....	15
2.3.2	Recommendation 2: Solar Energy System.....	15
2.3.3	Recommendation 3: Improve Air Tightness .....	15
2.3.4	Recommendation 4: Install Variable Frequency Drives.....	15
2.3.5	Recommendation 5: Retrocommissioning and Sub-metering .....	16
2.3.6	Recommendation 6: Water-source heat pump using a lake loop .....	16
2.3.7	Recommendation 7: Develop an energy-conscious conservation campaign ...	16
2.3.8	Recommendation 9: Clean radiator fins and windows .....	17
3	Technical Analysis 2: Lighting Retrofit .....	17
3.1	Existing Conditions.....	17
3.2	Evaluation of Lighting Retrofit Options .....	18
3.2.1	Option 1: LED Replacement.....	18
3.2.2	Option 2: Motion Sensors and Education.....	18
3.2.3	Option 3: Light Shelves and Controls.....	18
3.2.4	Option 4: Photocatalytic Coating.....	19
3.3	Cost of Proposed Lighting Options .....	19
3.3.1	Option 1: LED Replacement.....	19
3.3.2	Option 2: Motion Sensor Lighting and Education .....	20
3.3.3	Option 3: Light Shelves and Dimmers.....	20
3.3.4	Option 4: Photocatalytic Coating.....	21
3.4	Proposed Lighting Improvements .....	21
4	Technical Analysis 3: Solar Energy System.....	21
4.1	System Design .....	21
4.1.1	Location Selection .....	22
4.1.2	Panel Selection .....	23
4.1.3	Inverter Selection .....	24
4.2	Shading Study and Ballasted / Racking System .....	24
4.2.1	Shading Study.....	24



4.2.2	Racking System.....	26
4.2.3	Structural Assessment.....	27
4.3	Three Line Diagram.....	27
4.4	Cost of Proposed Solar Energy System .....	28
4.4.1	MicroFIT program .....	28
4.4.2	Energy Output.....	28
4.4.3	Cost and Return on Investment .....	28
4.4.4	Solar at the WNC .....	29
5	Schematic Estimate, Schedule, and Finance Plan .....	30
5.1	Cost Estimate.....	30
5.2	Schedule.....	31
5.3	Funding and Incentives.....	33
5.3.1	Toronto Hydro Retrofit Program .....	33
5.3.2	City of Toronto Better Buildings Partnership .....	33
5.4	Cash Flow and Finance .....	33
6	Outreach.....	34
6.1	Energy Awareness and Community Outreach.....	34
6.1.1	NLS Blog.....	34
6.1.2	University of Toronto Sustainability Conference .....	36
6.1.3	Gemini House Tour .....	36
6.1.4	Interaction with the City of Toronto.....	37
6.2	Feedback Letters and Documentation of Volunteer Efforts .....	37
6.2.1	Volunteering at Waterfront Neighbourhood Centre .....	37
6.2.2	Volunteering Hours .....	38
6.2.3	Feedback Letters .....	38
6.3	Article in Department / University Newsletter .....	39
6.4	CECA / NECA Chapter Interaction.....	40
	Works Cited.....	41
	Appendix.....	43
	Acknowledgements.....	43
	Panel and Inverter Specifications .....	44
	Solar Array Layout Calculations.....	46



# 1 Project Summary

## 1.1 Executive Summary

Northern Lights Solutions is excited to present its proposal for an energy retrofit at the Waterfront Neighbourhood Centre (WNC). Location at the foot of Bathurst Street along Queens Quay in Toronto, Canada, this three-storey 1997 building has not seen a major renovation since its construction, providing significant opportunity for an energy retrofit.

The WNC, whose services include family programs, workshops for seniors, and much-needed support for over 3,000 members in 2015 [1] alone, is currently hindered by low lighting, poor thermal comfort, and high electricity bills. Northern Lights Solutions developed this retrofit proposal to address their concerns, after two site visits, significant research, and consultation with industry experts.

The proposed energy retrofit of WNC includes a lighting retrofit and solar PV array. Existing fluorescent and metal halide lights will be replaced with more efficient LEDs and motion sensors will be installed, which will produce improvements in lighting quality along with a substantial decrease in energy consumption. WNC's open roof and unobstructed surroundings also provide an excellent opportunity to install a small scale solar energy system. The total project cost is \$75,847 to provide an annual 58,321 kWh of electricity savings and 7,936 kWh of solar production. This results in an annual bill savings of \$11,664 and solar revenue of \$2,468 and provides a 5.4 year simple payback. Further mechanical and building envelope improvements to address thermal comfort and heating energy may be pursued at the client's request.

Northern Lights Solutions has also developed and implemented a comprehensive outreach strategy throughout this proposal. This outreach strategy has improved communication and collaboration with both our client and industry partners and included our volunteering at WNC. This has included two events at WNC, blog posts, and a presentation to WNC and City of Toronto staff.

## Mission Statement

Our mission is to provide our clients with innovative solutions that will best address their needs in a cost-effective manner. We understand that there is no "one size fits all" solution, and our team makes every effort to deepen our understanding of our clients' needs in every project.

## Team Members and Roles

Our team is made up of 12 dedicated individuals who are led by six key members:

- **Rashad Brugmann** – Audit Lead: Responsible for planning the energy audit, compiling the data gathered, and leading the energy modelling;
- **Samson Tran** – Lighting and Systems Lead: Responsible for looking into practical ways to improve lighting quality and reduce electricity consumption;
- **Nataliya Pekar** – Solar Energy Lead: Responsible for offsetting a significant portion of the client's electricity with renewable electricity in the form of a solar energy system;
- **Greg Peniuk** – Estimation and Finance Lead: Responsible for costing of the project, developing a schedule that meets the client's needs, and developing a financing plan;
- **Sneha Adhikari** – Outreach Lead: Responsible for ongoing collaboration and volunteering with client as well promotion for NLS; and
- **Mackenzie de Carle** – Project Manager: Responsible for technical communications with the client, internal deadlines, and providing quality control for submissions.



## 1.2 The Client - Waterfront Neighbourhood Centre

Northern Lights Solutions has partnered with the Waterfront Neighbourhood Centre (WNC) for the 2017 Green Energy Challenge. The WNC is a not-for-profit community centre that provides a range of services to surrounding community members. It is located at the west edge of Toronto's Harbourfront neighbourhood on the north shore of Lake Ontario. The remnants of its industrial history are still very evident; it is sandwiched between abandoned concrete silos, the Billy Bishop Airport, and a residential district with a diverse and multicultural demographic. The WNC recently celebrated its 25th year of service to the community.

The WNC supports its diverse neighbourhood with a particular focus on vulnerable children, at-risk youth, and isolated adults with the goal to "improve the quality of life for everyone living in [their] neighbourhood". [1] In 2015, the WNC had 3,379 members and offered 2,185 activities and 84,866 hours of programming. [1] Examples of its services include: [1]

- **Family Programs** – Supports families with children ages 0-12 with parenting support and connects them with relevant medical, legal, and social assistance;
- **Children's Activities and Partnerships** – Includes nutrition programs as well as recreation and cultural events. WNC has many venues for recreation such as their very popular outdoor basketball courts;
- **Youth Leadership** – Focuses on youth aged 12 to 18 and works to develop youth into leaders in the waterfront community; and
- **Neighbourhood Seniors** – Engages local seniors with a variety of activities including weekly organic gardening.

Funding for WNC comes from a mix of sources. The City of Toronto pays for a portion of the administrative salaries and building costs. The rest of the funding, including the costs to run the bountiful programs and services, are funded through membership fees, donations, and activity fees. [1]

NLS chose the Waterfront Neighbourhood Centre, from among multiple other possible clients, because of the wide variety of services it offers and its significant impact on the community, making WNC a great choice for the Green Energy Challenge.

**Exhibit 1-1: Outdoor Basketball Court**





### 1.3 Facility Description

The WNC's 44,950 square foot space was constructed in 1997 and has not yet undergone significant renovation. This makes the building a great candidate for improvement as it is still generally in great shape but there is plenty of room to improve and to incorporate recent technological advances. WNC shares the building with The City School, Neo City Café, St. Stephen's Waterfront Child Care Centre, and Waterfront Public School, but separate entry doors provide independence to each organization. The City School has exclusive use of the second floor, where the classrooms are located.

WNC has the majority of the ground floor. Shared space includes the gymnasium and the parking garage. This is shown in **Exhibit 1-2** with the pink denoting WNC exclusive and yellow representing the shared space.

The gymnasium is used by the school during school hours and the rest of time, its use is under the control of WNC, thereby ensuring that the facilities are well used for the entirety of its operating hours. WNC operates Monday to Friday 9:30 AM to 9:30 PM as well as Saturday and Sunday 12:00 PM to 5 PM. The focus of this proposal is on the area that is exclusively used by the WNC plus the gymnasium, as it was identified as an essential space for WNC operations.

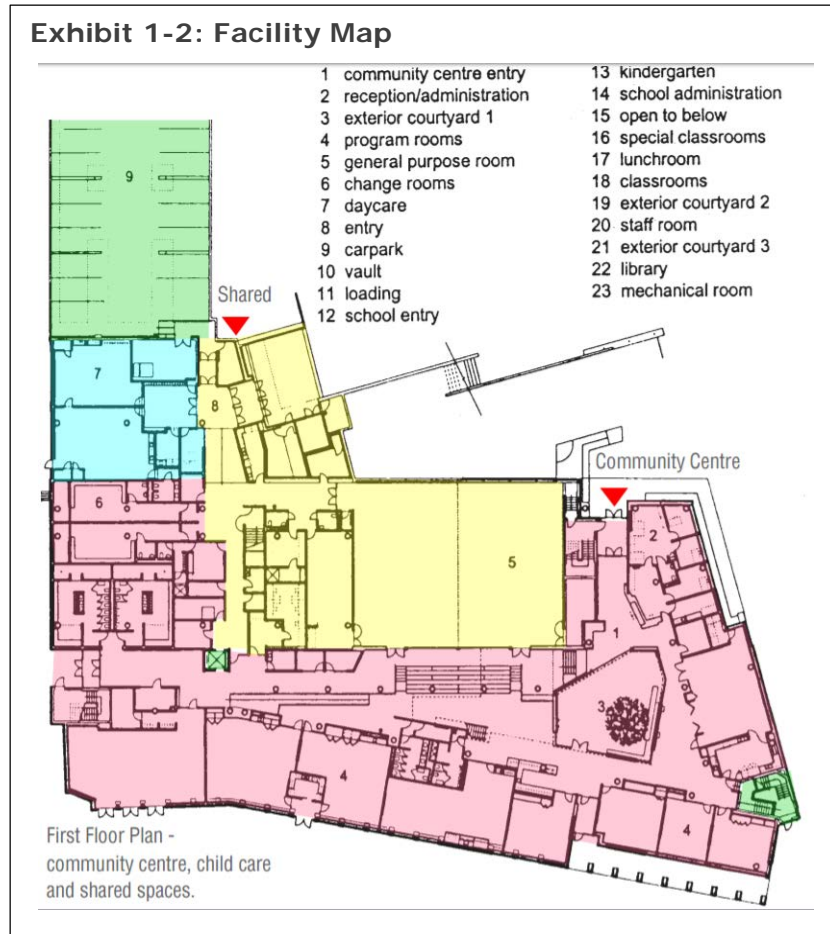



## 1.4 Northern Lights Solutions - The Project Team

The Northern Lights Solution team is made up of 6 core and 5 supporting students divided into five working groups, each of which are responsible for one aspect of the proposal. In the detailed organizational chart, illustrated in **Exhibit 1-3**, team leads are shown in boxes and are responsible for communicating their group's needs to the Project Manager as well as for ensuring that they achieve internal deadlines. Team members were encouraged to participate in multiple groups to gain exposure to a diverse range of experiences and to support the fluctuating work demands between the groups.

**Exhibit 1-3: NLS Organizational Chart**

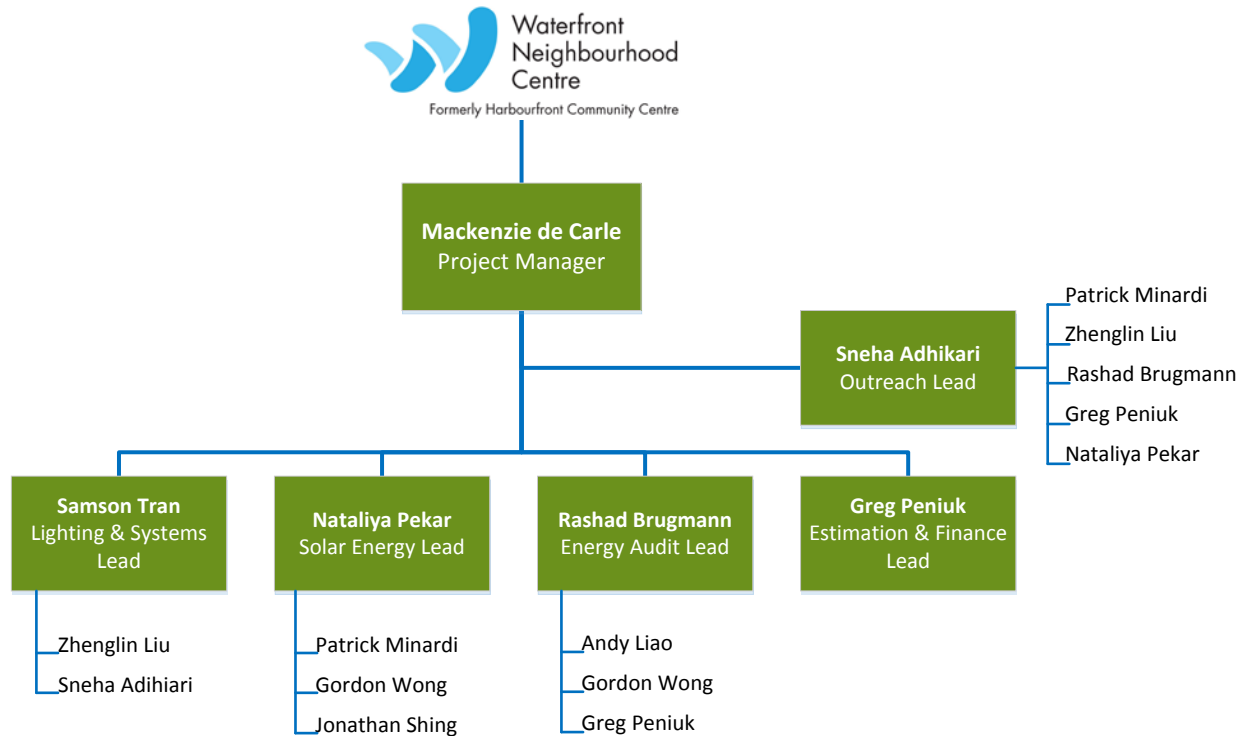

## Project Team Resumes

Project team resumes are provided below:



## Mackenzie de Carle

### Project Manager

Mackenzie has completed his third year of study at the University of Toronto for Civil Engineering, and is currently completing a 16-month co-op term with IBI Group in their Transportation Operations and Safety Group. He previously completed two 4-month work terms; one with Dillon Consulting in their municipal department and another with MMM in their rail department. Mackenzie brings his two years of team lead and industry experience as well as his work in client facing positions to his role as Project Manager.

Education	Skills & Certifications	Awards
BASc, Civil Engineering Class of 2017+PEY with Honours University of Toronto Toronto ON, Canada	<ul style="list-style-type: none"> <li><i>Applications:</i> Microsoft Office</li> <li><i>Software:</i> Revit, AutoCAD, Python, C, Google SketchUp, Solidworks, SurfCAM, Synchro</li> </ul>	1 <sup>st</sup> Place in Consulting at UTEK, 2 <sup>nd</sup> Place in Consulting at OEC, invited to and participated in CEC (Canadian Engineering Competition for Consulting)

## Relevant Experience

### Transportation Analyst, IBI Group

May 2016- Present

- Evaluated proposed site plans to assess their traffic impacts and necessary traffic mitigation measures
- Used second-by-second GPS data to evaluate the impact of traffic signal coordination and identify key intersections for further investigation
- Developed presentations, figures, and reports summarizing findings for clients

### AutoCAD Technician, Dillon Consulting Ltd

May 2015-August 2015

- Primarily produced AutoCAD drawings for site grading, site servicing, and road interchanges.
- Helped coordinate submissions for both the City of Toronto and Clients

### Construction Inspector, WSP (MMM Group)

May 2014-August 2014

- Worked on a subway station rehabilitation and upgrade for the TTC
- Work involved reading and interpreting construction drawings to ensure compliance with the design including steel and concrete works
- Helped report contractor's progress in regards to the schedule and activities completed

### Team Member, Survey Camp

August 2015

- Developed an RFP for a new research building on survey camp property
- Measured building temperatures with an IR pyrometer to assess optimum building orientation
- Measured wind speeds and solar irradiance to size necessary wind and solar facilities to power survey camp

## Extra-Curricular Activities

- **Project Manager**, CECA/NECA University of Toronto Student Chapter (2016-2017)
- **Lighting Retrofit Team Lead**, CECA/NECA University of Toronto Student Chapter (2016)
- **President**, CECA/NECA University of Toronto Student Chapter (2015-2016)
- **Estimation & Finance Team Lead**, CECA/NECA University of Toronto Student Chapter (2015)
- **Hull Design Lead**, Concrete Canoe (2016)





## Rashad Brugmann

### Audit team lead

Rashad is in his second year of study as a Civil Engineering student at the University of Toronto. He has a motivated interest in sustainable development and engineering leadership, and excitedly involves himself in projects with a breadth of topics surrounding sustainable engineering. Although he has not yet pursued professional experience in the field, Rashad is confident his experience and work ethic will serve him strongly.

Education	Skills & Certifications	Awards
BASc, Civil Engineering Class of 2019 University of Toronto Toronto ON, Canada	<ul style="list-style-type: none"> <li><i>Applications:</i> Microsoft Office</li> <li><i>Software:</i> AutoCAD, C</li> </ul>	Finalist, UofT EWB Global Development Case Competition. 2 <sup>nd</sup> Place, UBC Design Challenge.

## Relevant Experience

### Project Lead, Engineers for a Sustainable World UBC October 2015 – April 2016

- Implemented safety practices and pilot production schedules for on-campus biodiesel production
- Collaborated with other student groups to scale production

### Wilderness guide, Northwaters & Langskib Wilderness Programs June 2014 – present, seasonal

- Design and facilitate group- and personal-development initiatives throughout a three-week course
- Mentor participants and exercise peer leadership to manage risk

### Labourer, Lewis Creek Company October 2014 – December 2014

- Undertook construction labour for a green-building design-build firm
- Learned about building science from hands-on experience and efficiency audits

## Extra-Curricular Activities

- Audit Team Lead**, CECA/NECA University of Toronto Student Chapter (2017)
- Event coordinator**, CAGBC - Emerging Green Builders UBC chapter (2015 - 2016)
- Volunteer**, ICLEI – Local Governments for Sustainability at Rio +20 United Nations Conference on Sustainable Development (2012)
- UofT Engineering rugby team** (2016 – present)



## Samson Tran

### Team Lead – Lighting Retrofit

Samson is currently in his third year of Civil Engineering studies at the University of Toronto. His experience includes his work at the Ministry of Transportation Ontario, where he assisted the Investment Strategies Branch with their annual monetary allocation cycle. Samson delivers his experience in project management and academic knowledge in green energy throughout his participation in the Green Energy Challenge.

Education	Skills & Certifications	Memberships
BASc, Civil Engineering Class of 2018 with Honours University of Toronto Toronto ON, Canada	<ul style="list-style-type: none"> <li><i>Applications:</i> Microsoft Word, Excel, Powerpoint, Project, Publisher</li> <li><i>Software:</i> AutoCAD, Revit, Google Sketchup</li> </ul>	<ul style="list-style-type: none"> <li>Ontario Building Envelope Council</li> <li>CECA/NECA, University of Toronto Student Chapter</li> </ul>

### Relevant Experience

#### Transportation Technician Assistant, Ministry of Transportation Ontario May-August 2016

- Drafted accomplishment reports and spreadsheets to support the Investment Planning Section's monetary allocation processes
- Performed economic analyses on the costs of the MTO's highway projects to summarize highway conditions and funding outlooks
- Assessed asset management policies to develop guidelines while applying traffic principles
- Analyzed the progress of Ontario's highways through construction of graphs and figures
- Performed control tests in preparation for the MTO's Asset Management System software

#### VP Finance, Sustainable Engineers Association September–Present

- Research funding sources to finance over \$20,000 in activities to increase sustainability awareness at the University of Toronto community
- Develop the annual club budget by evaluating the requirements of proposed events
- Assisted with the planning and management of the annual sustainability conference, which brought together over 250 attendees and industry leaders to share their experiences in the sustainability industry

#### Team Member, Survey Camp August 2016

- Applied survey techniques to determine stations and corresponding cross sections, elevations, and earthworks calculation to develop a future highway proposal
- Experienced in differential levelling to lay out open and closed traverses
- Developed a professional-grade contour map to summarize information found in field studies

#### Student Competitions Director, Sustainable Engineers Association September–April 2016

- Designed and coordinated a case competition in collaboration with General Motors' to engage engineering students in sustainable transportation development
- Achieved budget reduction of over 20% by finding alternative methods to implement ideas

### Extra-Curricular Activities

- **Team Leader**, Green Energy Challenge - CECA University of Toronto Student Chapter
- **Design Member**, Steel Bridge Team at the University of Waterloo



## Nataliya Pekar

### Team Lead – Solar Energy Lead

Nataliya has completed her third year of study at the University of Toronto in Civil Engineering, and is currently on a 16-month work term with the City of Toronto in the Pedestrian Projects Unit of the Transportation Services Division. She previously completed a summer research term with the Structural Department of the University of Liverpool. Nataliya brings her technical skills, as well as experience with in-depth research, team management, and City of Toronto projects to her role as Solar Energy Lead.

Education	Skills & Certifications	Awards
BASc, Civil Engineering Class of 2017+PEY with Honours University of Toronto Toronto ON, Canada	<ul style="list-style-type: none"> <li><i>Applications:</i> Microsoft Office</li> <li><i>Software:</i> Adobe InDesign, MATLAB, Visual Basic (VBA), C, ArcGIS, AutoCAD</li> </ul>	1 <sup>st</sup> Place in Consulting at UTEK, 2 <sup>nd</sup> Place in Consulting at OEC, invited to and participated in CEC (Canadian Engineering Competition for Consulting)

## Relevant Experience

### Transportation Engineering Intern, City of Toronto

May 2016- Present

- Conduct research and make recommendations for development of engineering design guidelines
- Design, draft, and prepare quantity take-offs for road safety improvement projects
- Perform geospatial data retrieval, modification, and analysis to create map layouts
- Conduct reviews of existing conditions, propose improvements, and draft preliminary geometric design drawings

### Engineering Research Assistant, University of Liverpool

May 2015-August 2015

- Developed strategy to reduce cost and improve sustainability of welds in steel connections
- Designed and programmed an MS Excel spreadsheet to derive optimized layouts
- Communicated with steel fabricator on-site to understand implementation of welding in industry
- Performed a review to assess state of design codes and industry standards

### Project Facilitator, CECA/NECA U of T Student Chapter

October 2015-April 2016

- Performed role of client for 1st year Engineering Strategies and Practices course, requesting economic and sustainable transit extension from Toronto to Markham, ON
- Facilitated meetings, generated constructive feedback, and provided resources defining client needs, values, and constraints

## Extra-Curricular Activities

- **Civil Engineering Club Chair**, University of Toronto (2017-Present)
- **Solar Energy Lead**, CECA/NECA University of Toronto Student Chapter (2017)
- **Logistics Director**, CivicSpark (2016-2017)
- **Academic Director**, Civil Engineering Club (2015-2016)
- **Energy Audit Team Member**, CECA/NECA University of Toronto Student Chapter (2015)
- **Mentorship Director**, University of Toronto (2014-2015)



## Greg Peniuk

### Team Lead – Finance and Estimation

Greg is an Energy Systems Engineering student who has previously worked in the power industry and performed academic research in renewable energy technology. Greg brings broad knowledge of the evolving sustainability industry and an understanding of project finance to his role in the Green Energy Challenge.

Education	Skills & Certifications	Awards
BASc, Engineering Science Class of 2016+PEY with Honours University of Toronto Toronto ON, Canada	<ul style="list-style-type: none"> <li><i>Applications:</i> Microsoft Office</li> <li><i>Software:</i> VBA, MATLAB, Python, C, EnergyPlus</li> <li><i>LEED Green Associate</i></li> </ul>	Gordon Cressy Student Leadership Award

## Relevant Experience

### Planning Analyst, Independent Electricity System Operator May 2015-August 2016

- Quantifying the effects of energy efficiency, building codes, and retrofits on the operation of Ontario's electricity grid.
- Evaluating potential electricity conservation and emissions reduction programs by applying technical and financial tests.
- Producing detailed estimates of energy use in commercial, institutional, and industrial facilities in order to identify potential growth areas and opportunities for energy conservation.
- Researching global trends in renewable energy development and identifying the potential of disruptive new technology to dramatically alter grid operations and economics.

### Research Associate, University of Toronto May 2014-August 2014

- Directed a research project to create a new method for the analysis of microalgae in biodiesel production.
- Created new methods for collecting, managing, and synthesizing measurements from different sources.

### Finance and Fundraising Lead, Musical Minds Community Outreach September 2013-present

- Manages cash flow and documentation for a small non-profit, maintaining efficient operations.
- Identifies and pursues funding opportunities from government sources, foundations, and individual donors.
- Maintains databases to aid in record-keeping and daily operations.

## Extra-Curricular Activities

- Paddler**, Engineering Iron Dragons Dragonboat
- Team Member**, University of Toronto Quidditch
- Estimation & Finance Team Lead**, CECA/NECA University of Toronto Student Chapter (2017)
- President**, CECA/NECA University of Toronto Student Chapter (2016-2017)



## Sneha Adhikari

### Outreach Team Lead

Sneha has recently finished her third year in Civil Engineering at the University of Toronto. She has previously worked as a summer research student at the University of Toronto and will be starting a 16-month co-op as an Engineering Intern within the Transportation Services Division at the City of Toronto in May 2017. Sneha brings her leadership experience as a member of various extra-curricular activities into her role as Outreach Team lead for the Green Energy Challenge.

Education	Skills & Certifications	Awards
BASc, Civil Engineering Class of 2018 University of Toronto Toronto ON, Canada	<ul style="list-style-type: none"> <li><i>Applications:</i> Microsoft Office</li> <li><i>Software:</i> Revit, AutoCAD, C, Google SketchUp</li> </ul>	2 <sup>nd</sup> Place in the Engineers Without Borders (EWB) UofT Chapter Consulting Competition (2016)

## Relevant Experience

### Construction Safety Research Student May 2016-August 2016

- Collected data on safety climate in the construction industry by co-ordinating visits to over 200 construction sites within downtown Toronto.
- Analyzed the survey data by looking at correlations between worker demographics and corresponding safety incidents and compared results from similar research conducted in 2004
- Facilitated a secondary research project which reported on findings comparing urban pedestrian flow in regular sidewalks and construction overhead sidewalks.

### Academic Director, UofT Civil Engineering Club May 2016-May 2017

- Liaison between Civil Engineering class, Civil Engineering Department, and the Faculty in the matter of academic advocacy
- Student representative in the departmental Undergraduate Studies Committee looking into distribution of graduate attributes laid out by Canadian Engineering Accreditation Board (CEAB)

### Marketing Director, Skule's Got Talent April 2016-present

- Organized the annual talent show, "Skule's Got Talent", geared towards showcasing student talents of engineering students
- Utilized social media outlets to promote the event that summed to an audience of over 100 students for the final show

## Extra-Curricular Activities

- Outreach Team Lead**, CECA/NECA University of Toronto Student Chapter (2016-2017)
- Charity Subcommittee Chair**, University of Toronto Engineering Orientation (2016)
- Finishing Manager**, University of Toronto Concrete Canoe Design Team (2015-2017)  
CECA/NECA University of Toronto Student Chapter (2015-2016)
- Board of Director Civil Engineering Representative**, University of Toronto Engineering Society (2016-2017)



## 2 Technical Analysis 1: Energy Efficiency Analysis

### 2.1 Energy Audit Results

At the time of the energy audit, WNC staff provided the NLS team with electric and natural gas bills spanning December 2014 to January 2017. The team processed the data to extract monthly usage and investigate seasonal energy use variations, summarized **Exhibit 2-1**. As expected, electricity use is generally constant from year to year, with increases resulting from summer cooling demand. Natural gas consumption is highly variable. There were no changes to the building's mechanical system in this time, so the discrepancy is attributed to variations in weather. HVAC systems are discussed below.

**Exhibit 2-1: Energy Use by Month**

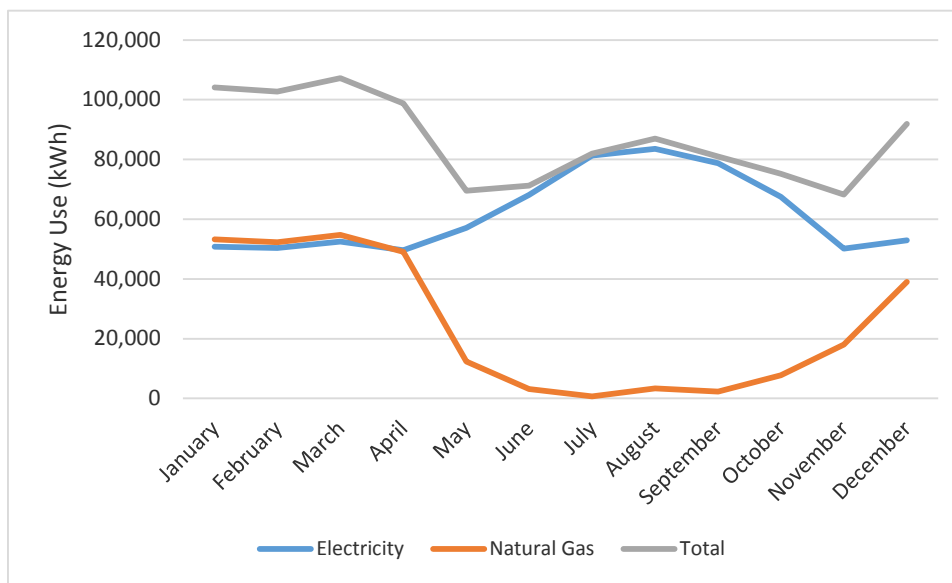

To derive energy end uses energy consumption at the WNC, the audit team subdivided the energy bill statement to reflect the two organizations in the building, WNC and Toronto District School Board (TDSB). Electricity bills are sub-metered with one bill for TDSB and one bill for the first floor which includes both WNC and shared space. Natural gas is not sub-metered and has a single bill for the entire facility. The WNC exclusive space and the gym are 64% of the first floor area, as such, 64% of the electricity bill was attributed to the study area. Similarly, 64% of the first floor is 50% of the entire building, thus 32% of the natural gas bill was assigned to the study area. It should be noted that all areas generally have similar envelopes – wall construction, window to wall ratio, and orientation. The electricity consumption at the WNC is shown in **Exhibit 2-2**.



**Exhibit 2-2: Electricity Consumption at WNC**

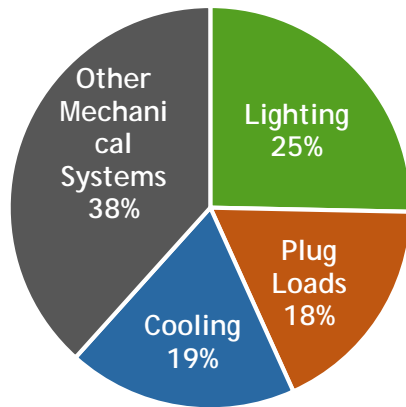

Staff at WNC complained of being cold in many areas of the building, reporting use of electric space heaters in their offices in both winter and summer. This indicates that heating is insufficient and air conditioning is too strong. The NLS team calculated that space heaters account for approximately 48% of electrical plug loads in the building, amounting to \$11,250 in 2016. Recommendations to improve thermal comfort in the facility and reduce consumption are discussed in **Section 2.4**.

**2.1.1 Lighting Summary**

The energy audit began by collecting data on the building lighting system, including bulb types and power, and interviewing the building manager to determine their hours of use. The results are summarized in **Exhibit 2-3**. The audit estimated that the annual energy use for building lighting is about 222,281 kWh, which equates to an intensity of 4.95 kWh/m<sup>2</sup>.

**Exhibit 2-3: Summary of Lights**

Location	Light type	Total wattage (W)	Weekday Operating Hours	Weekend Operating Hours	Nighttime Operating Hours	Total Operating Hours	Weekly Energy Use (kWh)
Hallways and Stairs (Location 1)	T8	4416	9am-9pm	11am-5pm	-	72	317
	Halide	17280	9am-9pm	11am-5pm	-	72	1244
	Compact Fluorescent	1066	9am-9pm	11am-5pm	-	72	76
Activity Rooms (Location 2)	T8	10432	9am-9pm	11am-5pm	-	72	751
	Compact Fluorescent	546	9am-9pm	11am-5pm	-	72	39
	Other	12514	9am-9pm	11am-5pm	-	72	901
Mechanical Room (Location 3)	T8	1856	9am-9pm	11am-5pm	Overnight (20% lights)	91.2	169
Outside (Location 4)	Building lights	10250	-	-	12 hr	72	777
SUM							4277
<b>ANNUAL ENERGY (kWh)</b>							<b>222,381</b>

**2.1.2 HVAC**

The facility is heated using a combination of radiant heat and forced hot air distribution. It is cooled with forced air cooling. Two 2657 MBH natural gas boilers heat up steam, which is



distributed to the space for radiant heating. The return steam is passed through a heat exchanger to transfer energy to glycol, which is distributed to four air handling units to heat up air supply. Cooling is provided via a 160 ton centrifugal chiller, which uses a cooling tower for heat rejection. The chilled water is distributed to the four air handling units for latent and sensible cooling. Ventilation is provided through nine rooftop fans, which bring fresh outdoor air to the air handling unit where it is mixed with return air before being filtered and redistributed to the space.

### 2.1.3 Building Envelope

The facility was built in 1997 to the modern energy efficiency standards. From inspection of drawings, NLS confirmed that most exterior walls are built of 250 mm blocks of concrete, insulated externally with 75 mm of rigid cavity insulation (R-20), followed by a well-vented air gap and finished with a brick facade. NLS estimated the total thermal resistance to be around R-22. The Supplementary Standard SB-10 of the Ontario Building code, amended in July 2011, prescribes a minimum exterior insulation of R-11 plus an interior insulation of R-12, so the building is slightly below building code requirements for new construction. All the windows are double glazed units, manufactured by Triple Seal LTD, with metal frames. NLS estimated the window to wall ratio to be around 0.2 for the entire building, with the east wall having the most glazing and the north one the least.

NLS also assessed the envelope by using thermal images (**Exhibit 2-4**) of areas where significant thermal bridging and where possible air leaks would be expected, such as around window frames and doors. The temperature during our visit was 19.2°C indoors and 1°C outdoors. The images indicate thermal bridging and possible air infiltration around the doors and windows.

**Exhibit 2-4: Thermal Image of Building Envelope**

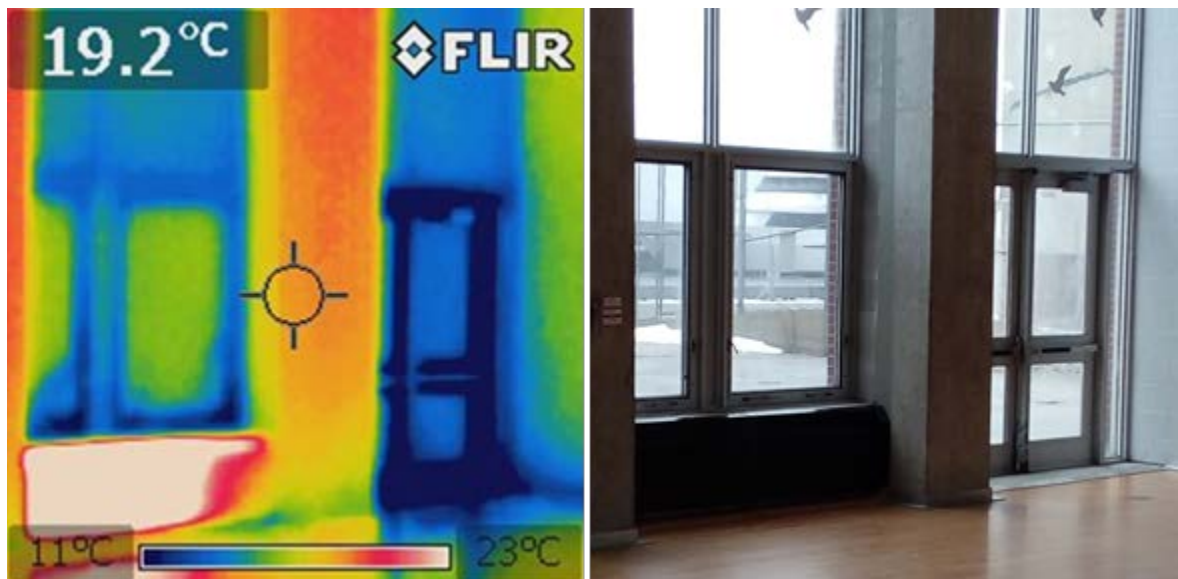





## 2.2 Energy Benchmark

Two programs were used to perform an energy benchmark analysis for the Waterfront Neighbourhood Center. The first program was the EPA Portfolio Manager; the second program is the Building Asset Score created by the US DOE.

### 2.2.1 EPA Portfolio Manager

NLS determined that the facility would be best modeled as a fitness centre/health club/gym class of building due to long hours of operation and many activity rooms with appliances. However, the EPA does not provide an Energy Star score for this class of building.

With energy use history, the tool estimates that the source EUI of the facility is 708 kWh/m<sup>2</sup>, 32% higher than the national median EUI for the property type. Furthermore, the tool estimates a site EUI of 408 kWh/m<sup>2</sup>, which is higher than the national median. The difference between the site and source EUI is defined by the scope of energy use. Site EUI accounts only for energy consumption onsite while source EUI accounts for total raw energy required to operate the building and accounts for the losses from generation, transmission and distribution to the WNC. The results show that compared to a fitness centre of the same size, the WNC uses 32% more energy on site. This suggests there are feasible mechanical and lighting improvements to be made to improve the building's energy efficiency. It is also important to consider that the building class chosen may underestimate a reasonable EUI. Additional results of the evaluation are summarized in **Exhibit 2-5**.

**Exhibit 2-5: Results of EPA Portfolio Manager Benchmarking**

Energy Consumption and Energy Use Intensity (EUI)			
<b>Site EUI</b> 1.47 GJ/m <sup>2</sup>	<b>Annual Energy by Fuel</b>		<b>National Median Comparison</b>
	Electric - Grid (GJ)	2,701 (68%)	National Median Site EUI (GJ/m <sup>2</sup> )
	Natural Gas (GJ)	1,240 (32%)	National Median Source EUI (GJ/m <sup>2</sup> )
			% Diff from National Median Source EUI
			32%
<b>Source EUI</b> 2.55 GJ/m <sup>2</sup>	<b>Annual Emissions</b>		
			Greenhouse Gas Emissions (Metric Tons CO <sub>2</sub> e/year)
			151

### 2.2.2 DOE Building Asset Score

The building asset score by the Department of Energy focuses on five categories: lighting, water heating, HVAC, building operations, and physical shape of the building. To address the complexity of the shared mechanical system, NLS used extensive notes from the energy audit, building drawings, and consultations with University of Toronto professors. The results of the evaluation are provided in **Exhibit 2-6**.

The WNC's DOE Building Asset Score is 6.5 out of 10. WNC's energy efficiency is acceptable, but there is potential for improvement. As expected for a large facility, the cooling of the building is the most energy-intensive system. In addition, the tool does not allow for the addition of the radiant heat to the building model. Therefore, the system containing radiant heat, a heat exchanger, and forced air heating was modelled as if it were a steam loop used for forced air heating. This may explain the large discrepancies in the heating and cooling energies. Interior lighting is also a major component of building energy consumption. With over 50 kW of lighting fixtures in the building using fluorescent and halide technology, there is considerable energy savings potential from a lighting retrofit, as seen in Section 3.

The DOE asset score also provided a value for the site and source EUI, 225 kWh/m<sup>2</sup> and 725 kWh/m<sup>2</sup> respectively. Compared to the 408 kWh/m<sup>2</sup> and 708 kWh/m<sup>2</sup> from the Energy



Star Portfolio Manager, the source EUI were close, but the site EUI has a 57.9% difference. This difference could be explained due to the difference in the benchmarking software. The DOE asset score focuses on the building's shape, installed lighting and HVAC system, and operations, while the Energy Star Portfolio Manager considers energy bills.

**Exhibit 2-6: Results of DOE Building Asset Score**

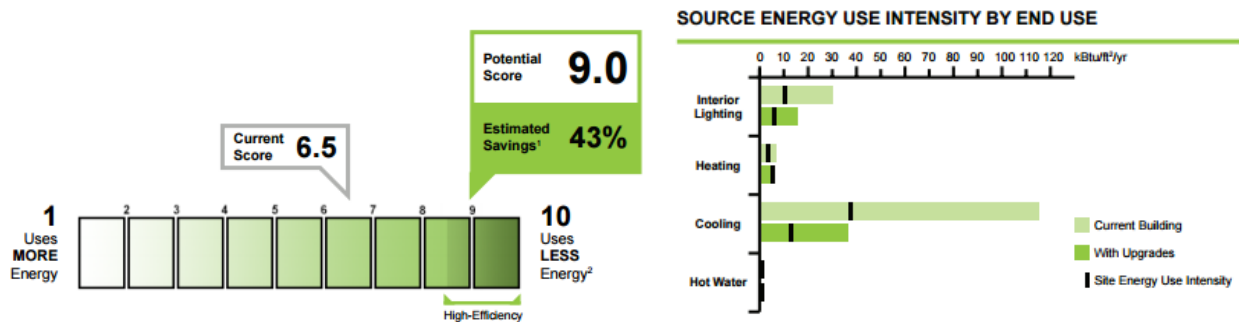

## 2.3 Proposed Improvements

After analyzing the energy consumption and benchmarking estimates of the WNC facility, the NLS audit team recommends several improvements to reduce energy consumption. Some options, such as heat recovery ventilation technology, were considered but ultimately not recommended due to the building configuration and poor cost-effectiveness.

### 2.3.1 Recommendation 1: Lighting Retrofit

The audit team recommends investigating a lighting retrofit for the WNC to improve electrical efficiency. Specific retrofit measures are evaluated in **Section 2** of this report.

### 2.3.2 Recommendation 2: Solar Energy System

The audit team observed that the building's flat roof has large unused and unshaded areas suitable for a PV array. The proposed solar system is evaluated in **Section 3**.

### 2.3.3 Recommendation 3: Improve Air Tightness

Although our analysis did not include advanced techniques for assessing air tightness, infrared imaging indicates that window frames and doors may be leaky. It is likely that the original seals created at construction 20 years ago have degraded. NLS recommends that future maintenance activities include resealing the window frames and installing new weather stripping around the doors. This will improve the thermal comfort of WNC patrons and staff and reduce the energy consumption for heating. Improvements in air tightness can reduce heating loads by 10-13% [2] which could provide savings of 21,000 kWh / year or \$4,200 per year, assuming half of all leaks are sealed.

### 2.3.4 Recommendation 4: Install Variable Frequency Drives

At the WNC, fans and pumps are constantly running on a single setting, adjustable only with analog knobs, meaning there is no automation to optimize either human comfort or energy consumption. Although proximity to Lake Ontario offers a thermal cushion to the WNC's annual climate, diurnal temperature fluctuations still exist, which is why NLS recommends a thermal feedback system.

The current HVAC system consists of a single phase condenser fan motor and a three-phase compressor motor. A variable frequency drive (VFD) will allow the pumps and fans to



operate more efficiently. VFD have been shown to produce energy savings of 10-40% and often have a payback of 2 to 4 years. [4] This could provide a savings of 16,000 kWh or \$3,200 annually.

### **2.3.5 Recommendation 5: Retrocommissioning and Sub-metering**

Retrocommissioning is suggested after installing the variable frequency drives for all compatible pumps and fans. The procedure includes removing debris built up inside HVAC system shells, and oiling moving components. Pumps outlets may need to be calibrated to ensure all air escapes ventilation. All pump tubes shall be examined for defects.

Finally, the retrocommissioned VFD/HVAC system shall be calibrated to WNCs average indoor climate over the course of two weeks. This includes monitoring energy consumption and human comfort at all points in the building. The optimal settings may be used as a reference point as the seasons progress.

To provide ongoing data on energy performance, the WNC could install sub-meters for the HVAC systems and in rooms. This data could be used for identifying further improvements. Sub-metering would allow the facility operators to monitor energy performance and track how behavior or equipment changes energy use in specific areas. Finally, real-time disaggregated data could make the building operators and users more energy-conscious.

Retrocommissioning typically produces energy savings of 13-16% [5]. Assuming a conservative reduction of 10%, WNC would experience a savings of 42,250 kWh or \$8,200.

### **2.3.6 Recommendation 6: Water-source heat pump using a lake loop**

The chiller installed at the WNC is from 1996 and should be replaced. NLS recommends retrofitting the building with a geothermal heat pump to provide cooling when the chiller reaches end-of-life. Taking advantage of nearby Lake Ontario, the lake can be used as the heat sink for the system. A lake-loop geothermal system easy to install, requiring only submerging the heat exchanger coil to a sufficient and safe depth. The system would require a heat exchanger in the mechanical room connected to the outside coils.

NLS recommends using the heating capability of such a geothermal system in conjunction with the existing forced air heating system. The building's radiators combat perimeter heat losses through the building, so replacing them entirely is unfeasible. By using the geothermal heat exchanger to heat air, utilization of the boilers can be reduced. This system would greatly increase the efficiency of the building's heating and cooling.

Using a water-source heat pump has been shown to reduce HVAC energy consumption by 8-40% [6]. Therefore assuming a conservative 8% energy consumption, WNC could reduce their energy use by 33,800 kWh/year or \$6,760 per year.

### **2.3.7 Recommendation 7: Develop an energy-conscious conservation campaign**

NLS proposes developing an educational campaign at WNC to encourage patrons and staffs to 1) turn off lights and 2) unplug appliances when either are not in use. It is estimated that domestic appliances draw 0.5–30 W as phantom load – energy consumption when plugged in but not powered [3]. Using an average phantom load of 7 W for WNC's 88 appliances, WNC could save 5150 kWh of energy and \$1030 annually by unplugging their irregularly used domestic appliances.



### 2.3.8 Recommendation 9: Clean radiator fins and windows

A final recommendation to address the thermal discomfort of WNC patrons and staff is to clean both the radiator fin surfaces and the building's windows. This would increase heat transfer from the radiator –this is a low-cost solution with potentially high improvements to heating which should be investigated. Similarly, cleaning the windows of the building would maximize solar gains and warm the building. While this is part of regular maintenance at WNC, the frequency of these cleanings could be increased to improve thermal comfort and reduce energy use.

## 3 Technical Analysis 2: Lighting Retrofit

### 3.1 Existing Conditions

The building mostly consists of three types of lights serving multiple purposes. The facility is open to the public from 9:30 AM to 9:30 PM on weekdays and 12:00 PM to 5:00 PM on weekends. There are 336 32 W 4100k T8 total fluorescent lights in all indoor activity rooms. An additional 186 T8s are operated in hallways and the mechanical room. There are 37 outdoor pot lights surrounding the facility that are on 12 hours per night on average. In addition, there are 51 circular-paneled 13 W compact fluorescent lights in a few rooms. With a weekly indoor and outdoor light usage of approximately 70 and 84 hours respectively, there opportunity for the client to reduce energy use. Many rooms, offices and activity rooms include panels with 32 W 4100k T8 fluorescent tube lights. The Dance Room is one of WNC's larger activity rooms. It requires high lighting quality and benefits from considerable daylighting. To assess the interaction of daylight with the installed fluorescent lighting in this room, we have prepared a detailed study of the lighting in **Exhibit 3-1**.

**Exhibit 3-1: Dance Studio Reflected Floor Plan and Rendering**

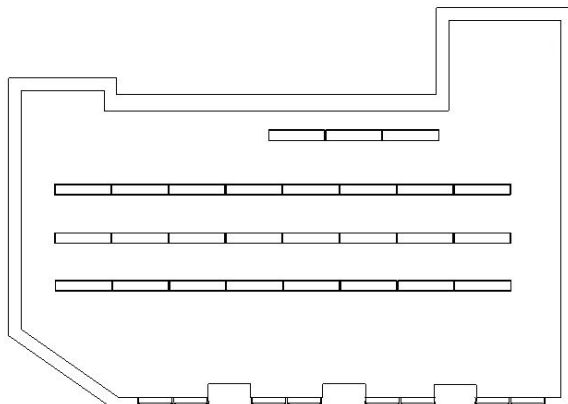

As part of the energy audit, NLS evaluated the lighting quality of each room in the WNC. Lighting intensities for each type of room were recorded during the energy audit and compared to standards developed by the Illuminating Engineering Society of North America (IESNA). There were multiple rooms in the WNC that did not meet these requirements. Their measured light levels and the recommended light levels are provided in **Exhibit 3-2**.

Light intensity averaged 400 lux or more in the highly fenestrated eastern side of the building. However, light in these rooms was not evenly distributed and some sections remained below recommended light levels. NLS hopes to address this concern for the client.



**Exhibit 3-2: WNC Rooms that do not Meet IESNA Recommendations**

Room	Average Current Light Level (lux)	Recommended Light Level Range (lux) [4]
Assembly A	200	300-500
Assembly B	150	300-500
Assembly C	150	300-500
Recording Studio	150	300-500
Reception Office	200	300-500
General Office	75	300-500
Weight Room	100	200-300

**3.2 Evaluation of Lighting Retrofit Options**

Four measures are detailed to provide building occupants with better lighting quality and reduce energy requirements: 1) conversion of existing lights to LEDs, 2) motion sensors and improved education, 3) installation of light shelves, and 4) implementation of photocatalytic coating on windows.

**3.2.1 Option 1: LED Replacement**

For the replacement of the 32 W T8 light fixtures, NLS recommends using 13 W LED light fixtures. 13 W LED lights are the lowest energy option that meet IESNA lumen recommendations. The reception office had the highest lighting needs, requiring 13 W LEDs. Converting 522 T8 tubes from 32 W fluorescents to 13 W LEDs could save approximately 38,233 kWh per year.

The WNC’s building manager has noticed that the 400 W metal halide lights in the gym are dim. Metal halide lights are known for suffering substantial lumen depreciation after few years of use. Because LEDs offer higher efficiency and more downward-directed light, 160 W LEDs would be sufficient to replace the 400 W lamps. Beyond the energy savings resulting from this retrofit, brightness in the gym should be higher and the LEDs should last over 20 years before requiring any maintenance. This is particularly important as a lift must be brought in to replace these lights, which is both expensive and time-consuming.

**3.2.2 Option 2: Motion Sensors and Education**

At the WNC, many of the activity rooms are unoccupied for 30-50% of the facility’s operating hours. In the short term, this lighting demand could be reduced through a focused community education campaign. NLS made considerable efforts towards community education this year through our outreach portfolio **Section 6**. NLS also suggests that WNC track energy usage in the form of an informal audit more frequently to assess locations in need of improvements in terms of using lights more efficiently.

A longer-term solution to lighting of unoccupied rooms is the installation of motion sensor control. Ten motion sensors would be needed for the activity rooms. Manual switches will be retained to allow facility users to control lights as needed.

**3.2.3 Option 3: Light Shelves and Controls**

Light shelves are reflective horizontal surfaces placed at the window to reflect sunlight farther into the room. They can reduce the amount of artificial lighting required during the daytime. WNC currently has six rooms facing south and east with high daytime light levels, greater than 400 lux, where light shelf installation could improve lighting conditions. These rooms have 14 windows to install light shelves on. Studies have shown that light shelves



can extend sunlight from 3 to 7 metres into a room. [5] Most of the six rooms have a width of 7 metres with the largest being 9.5 metres. We estimate that properly installed light shelves could reduce lighting demand in these rooms by 15%. Additionally, NLS recommends adding improved lighting controls to take advantage of daylight. This implementation would require a new layout of blinds, separately above and below for maximum adjustability.

### 3.2.4 Option 4: Photocatalytic Coating

Innovations in window glazing have provided users with energy savings in the recent past. To reduce the impact of window soiling on indoor light, we suggest replacing all 24 activity room windows with photocatalytic coated windows. This coating contains nano-scale titanium dioxide particles, which can help windows 'self-clean' when exposed to natural sunlight. By breaking down organic dirt, the coating can increase the amount of light that passes through. Researchers state they require little maintenance and dry rapidly, so our client can benefit not only from improved lighting but also reduced window maintenance costs.

## 3.3 Cost of Proposed Lighting Options

This section analyzes the financial and electricity benefits of the different options. Electricity costs were assumed to be \$0.20 / kWh. All costs were calculated in Canadian Dollars. These screening estimates include material and labour only; overhead costs and utility incentives are considered in **Section 5**.

### 3.3.1 Option 1: LED Replacement

For the implementation of the LED lights, the analysis is provided below. Capital costs for the lighting assumed for each one-inch diameter 13 W tube are \$30 for material and \$25 for labour, multiplied by the 522 32-Watt T8 fluorescent tubes being replaced. A summary of the evaluation of LED replacements is shown in **Exhibit 3-3**.

**Exhibit 3-3: Evaluation Summary of LED Replacement of T8s**

Criteria	Base Case (T8 Fluorescent) [6]	Replacement with 13 W LED [7]
Hours / year	3,744	3,744
Lifespan (years)	10 [1]	13 [2]
Electricity Use (kWh/yr)	62,540	25,407
Electricity Savings (kWh/yr)	-	37,133
Capital Cost (\$)	-	28,710
Payback (years)	-	3.9

Material costs are \$468 for each of the 18 LEDs that must be purchased to replace all gym lights. Because the installation is complex and will be done over 20 ft high, labour costs have been generously estimated at \$183 / unit. A summary of the gym light replacement costs is shown in **Exhibit 3-4**. We have not financially evaluated the reduction in maintenance costs from replacing the metal halide lamps.



**Exhibit 3-4: Evaluation Summary of LED Replacement of Gym Lights**

Criteria	Base Case (400 W Metal Halide)	Replacement with 160 W LED
Hours / year	3,744	3,744
Lifespan (years)	5	27
Electricity Use (kWh/yr)	26,957	10,783
Electricity Savings (kWh/yr)	-	16,174
Capital Cost (\$)	-	11,718
Payback (years)	-	3.6

**3.3.2 Option 2: Motion Sensor Lighting and Education**

This option would require installation of 10 motion sensor devices (one per activity room). There is a total of 268 lamps in the activity rooms. Estimating that the rooms are occupied 70% of the time, the following table presents the amount of energy saved, capital cost, and payback period. The motion sensors we have selected cost \$25 for materials and \$100 for installation. [8] [9] A summary of the impacts of installing motion sensor is illustrated in **Exhibit 3-5**.

Until the motion sensors are installed, the WNC could consider improved education as a short-term measure. This option would require programming and marketing efforts, likely implemented by staff, to increase energy education and awareness for the community.

**Exhibit 3-5: Evaluation Summary of Motion Sensor Lighting in the Activity Room**

Criteria	Base Case (T8 Fluorescent)	Installation of Motion Sensor Lighting
Hours/year	3,744	2,621
Electricity Use (kWh/yr)	32,109	22,476
Electricity Savings (kWh/yr)	-	9,633
Capital Cost (\$)	-	1,250
Payback (years)	-	0.6

**3.3.3 Option 3: Light Shelves and Dimmers**

With the addition of the light shelves on the windows, the energy and cost savings are summarized below. Currently, each room uses 32 W T8 fixtures. The total cost of the light shelf system includes: \$235 to upgrade lighting control in each of the 6 east-facing rooms and \$200 for each of the 14 windows. A summary of the impacts of installing light shelves and improved controls is illustrated in **Exhibit 3-6**.

**Exhibit 3-6: Evaluation Summary of Light Shelves and Controls in the Activity Rooms**

Criteria	Base Case (T8 Fluorescent)	Installation of Light Shelves and Controls
Hours/year	3,744	3,744
Electricity Use (kWh/yr)	23,243	19,756
Electricity Savings (kWh/yr)	-	3,486
Capital Cost (\$)	-	4,210
Payback (years)	-	6.0



### 3.3.4 Option 4: Photocatalytic Coating

The following table estimates the amount of savings achieved with this option and provides the payback time. This option would require replacing all 24 room windows with photocatalytic coated windows. Labour cost is assumed to be \$50/hour, with an installation time of approximately two days. The cost of these innovative windows is estimated to be 20% higher than windows using standard clear glass [10]. With the average cost of standard windows being \$600, the capital cost of this option is an estimated \$18,000.

With self-cleaning windows, the annual price of cleaning can be removed. It was surveyed to cost around \$3000 for low-rise buildings, similar to the WNC [11]. A summary can be found in **Exhibit 3-7**.

**Exhibit 3-7: Evaluation Summary of Photocatalytic Coating**

Criteria	Installation of Photocatalytic Coated Windows
Capital Cost (\$)	18,000
Annual Savings (\$)	3,000
Payback (years)	6

## 3.4 Proposed Lighting Improvements

A summary of the options discussed is presented in **Exhibit 3-8**. For the initial screening of proposed retrofits, only costs associated with materials and installation are estimated. Savings were also estimated for each option individually, without considering interaction between the options. For example, the combined savings of LED lighting and motion sensors would be lower than the sum of the savings from each option individually.

**Exhibit 3-8: Summary of Proposed Lighting Improvements**

Option	Capital Cost (\$)	Simple Payback Period
1a: LED retrofit, 32 W fluorescent	28,710	3.9
1b: LED retrofit, 400 W gym lights	11,718	3.6
2: Motion sensors	1,250	0.6
3: Light shelves and dimmers	4,210	6.0
4: Photocatalytic window coating	18,000	6.0

NLS will accept the LED retrofit and motion sensors because their payback periods are shorter than 4 years based on our preliminary analysis. A detailed estimate and financing plan will be developed in **Section 5** to assess the true payback period.

## 4 Technical Analysis 3: Solar Energy System

NLS has designed a 16 panel, 5kW array for installation on the Waterfront Neighbourhood Centre roof. The system has been designed based on a detailed shading study and rigorous product assessment. It will produce an average of 7,936 kWh a year that will be sold directly to the grid through Ontario's microFIT program.

### 4.1 System Design

For the design of the PV system, the team has evaluated best practices, emerging technologies, and client needs. Detailed below are the proposals for the PV system.





### 4.1.1 Location Selection

Locations considered for the installation of solar panels included the roof, surrounding grounds, and building facade. **Exhibit 4-1** details factors considered in location choice.

**Exhibit 4-1: Considerations for Location Selection**

Consideration	Impact
Space	As shown in <b>Exhibit 4-2</b> the roof is a relatively flat and clear surface with few barriers, allowing for installation of panels.
Future Development	The Bathurst Quay Neighbourhood Plan - a City of Toronto planning study detailed future development surrounding the waterfront neighborhood centre. Surrounding land will be utilized as recreational or park lands as illustrated in Exhibit 4 2 [12].
Ontario microFIT	Ontario's microFIT incentive program requires additional land-use planning and municipal certification for non-roof installation [13].
Solar Exposure	A shading study shown in <b>Section 4.2</b> identified the north-east corner of the building as the ideal location for solar panel installation. Finally, nearby buildings with rooftop solar panels have set a precedent for successful PV array projects.

**Exhibit 4-2: Aerial Images and Nearby Buildings Suggest Suitability for Solar**





**Exhibit 4-3: Future Land Use Surrounding WNC [12]**

**A Framework Plan**

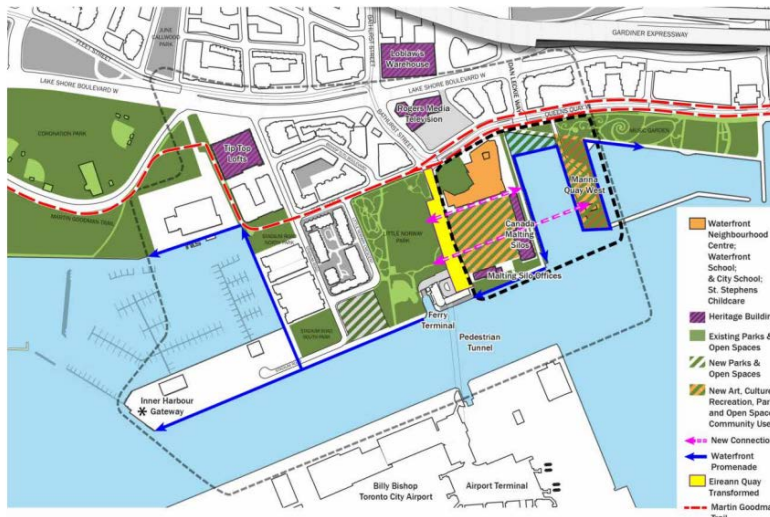

The Framework Plan illustrates the Vision to complete the community including transforming the Canada Malting Silos Site and Marina Quay West into a new Placemaking Waterfront Destination.

In accordance with the results found in **Exhibit 4-1** and in consideration of the shading study in **Section 4.2**, the roof has proven to be an excellent candidate for a PV array.

**4.1.2 Panel Selection**

A solar panel was selected based on a comparison of five top-rated panels. A decision matrix was used to compare the panels through factors described in **Exhibit 4-4**.

**Exhibit 4-4: Panel Evaluation Factors [14]**

Factor	Justification
Weight (kg/Watt)	A lighter panel is preferred.
Temperature Coefficient Rating	A lower coefficient is preferred.
Efficiency	A higher efficiency is preferred.
Durability (warranty)	Longer warranty is preferred.
Cost (\$/Watt)	Lower cost is preferred.
Type: Monocrystalline vs. Polycrystalline	Monocrystalline is preferred as an emerging technology due to higher efficiency, better performance at higher temperatures, and better overall performance [15].

**Exhibit 4-5: Panel Decision Matrix**

Objective	CSA MAXPOWER CS6X-325P [16]	Canadian Solar CS6U-345M [17]	Heliene Inc 73P – 300W [18]	GS-P60-265-Fab2 [19]	Hanwha HSL 255-60P [20]
Cost/Watt	1	2	4	3	4
Efficiency	2	1	5	3	4
Warranty	1	1	1	1	1
Weight	1	1	2	2	3
Temperature	2	1	2	3	3
Type	1	1	2	3	3
Total	8	7	16	15	18



The numbers in the matrix above represented order of best to worst in each category. The category with the lowest score has outweighed all others.

Ultimately, the team chose to recommend the Canadian Solar CS6U-345M panel based on its performance in a comparison shown in **Exhibit 4-5**. The panel has a large output for its cost, has the highest efficiency, is monocrystalline, and is manufactured closer installation, reducing environmental impact of transportation.

### 4.1.3 Inverter Selection

The team chose an inverter based on an in-depth analysis of inverters available on the market, considering type, efficiency, cost, warranty, and operating temperature range.

Currently, two types of inverters are on the market, the string inverter and the micro-inverters. NLS is recommending a string inverter. String inverters offer increased resiliency, lower cost, and ease of installation. Conversely, micro-inverters are 20-30% more expensive, increase risk of system failure, and are generally chosen when parts of the system are frequently shaded [21]. As per **Section 4.2.1**, the solar installation on the WNC will not experience frequent shading. NLS proposes the Fronius IG Plus V 5.0 string inverter.

The Fronius IG Plus V 5.0 string inverter was chosen because of the manufacturer's reputation in quality, it's ease of installation, warranty, and compliance with microFIT requirements. The Fronius also comes with the ability to monitor output - a key educational opportunity for the community centre and elementary school that shares the building [22].

An option for the WNC is the addition of optimizers. They are installed for each panel and condition the DC output to optimize performance of the entire array [23]. Because they are recommended for array's with frequent shading, they are not warranted for the WNC.

## 4.2 Shading Study and Ballasted / Racking System

### 4.2.1 Shading Study

To conduct a shading study, as shown in **Exhibit 4-6**, the team utilized Autodesk Revit to render the WNC and surrounding buildings. The centre is located close to Toronto's waterfront and only one building was identified to cause shading. After rendering the two buildings in Revit, a shading analysis was run for noon of the winter solstice. No shade was cast on the roof or on the surrounding grounds west of the building.



### Exhibit 4-6: Revit Solar Shading Analysis Set Up

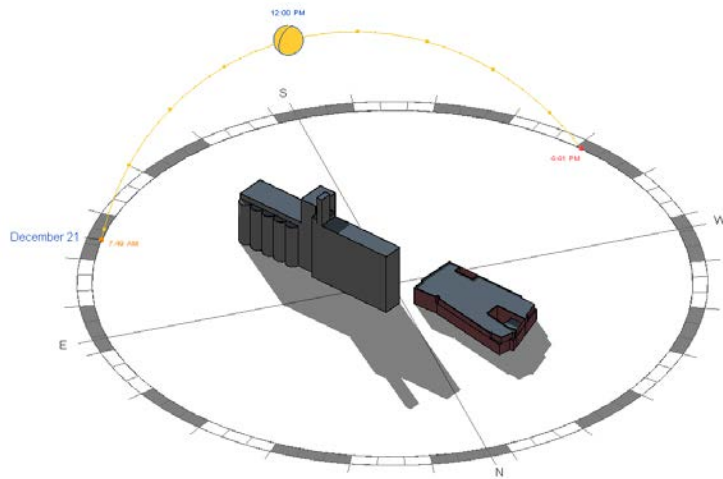

The Canada Malting Silos, modeled above in **Exhibit 4-6**, is the only building located south of the WNC at 5 Eireann Quay and is the only potential cause of shading. The building is about 66m at its highest peak and has been deemed a heritage site by the City of Toronto.

Through the solar analysis, it was determined that the WNC would only experience shade in the early morning hours. These hours do not provide high output therefore the effect from shading is minimal. **Exhibit 4-7** illustrates the shading on the roof at solar noon for the winter solstice, vernal equinox, summer solstice, and autumnal equinox.

### Exhibit 4-7: Solar Shading Study

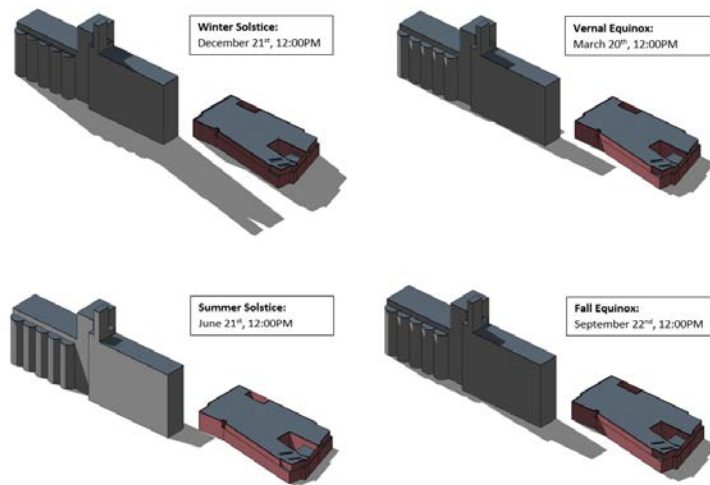

The team recommends the north-east corner of the building for a PV Array due to minimal shading and adequate open space. Panel spacing between the two rows of eight panels has been set at 5 m to avoid shading from the south array onto the north array [24]. Detailed calculations, based on the Winter Solstice and a 36.2° tilt, are located in the **Appendix**.

Based on the shading study and recommended 36.2° tilt, this spacing should accommodate up to an 11-hour solar window. **Exhibit 4-8** illustrates the panels on the north-east corner of the roof during solar noon hours with no negative shading effects present.



**Exhibit 4-8: Spacing is Adequate to Prevent Shading**

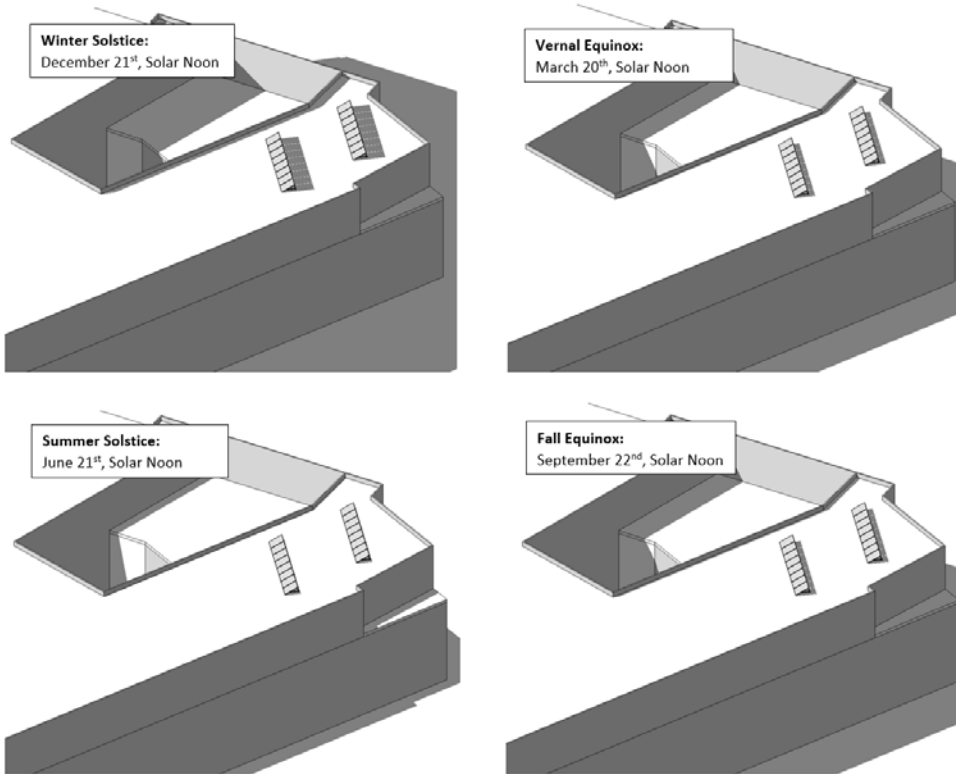

**4.2.2 Racking System**

The PV array must be attached to the roof using a racking system that considers tilt angle and orientation, weight, cost, installation requirements, drainage, and rooftop units [25].

A tracking system was considered but disqualified due to decreased suitability for snow heavy climates, additional installation requirements, and increase in maintenance costs, all of which are outside of the client’s scope and capacity for a 5kW system [26].

Two key systems exist for the racking of solar panels: an attached system, a ballasted system, or a hybrid of the two. An attached system depends on penetrations into the roof and attachments into the framing. Alternatively, a ballasted system relies on weight.

A comparison table has been made to evaluate the systems.

**Exhibit 4-9: Racking Comparison Table [25]**

Factor	Attached vs. Ballasted
Weight	Attached > Ballasted: Attached is a lower weight system.
Array Tilt	Attached > Ballasted: Attached is able to withstand larger tilts, ballasted typically reaches a maximum at about 20°.
Installation	Ballasted > Attached: Ballasted has a simpler installation with fewer engineering requirements.
Wind Loads	Attached > Ballasted: Attached can withstand higher wind loads.
Cost	Attached > Ballasted: Attached systems are lower in material cost but may be higher in cost engineering, inspection, and installation.

The team will recommend the use of an attached system. The location of the WNC along the waterfront, with few obstructions, indicates high winds. Moreover, based on results in



**Section 4.4.2**, an optimal tilt between 19.6° and 57.4° requires an attached system. Finally, the attached system reduces dead load to the structure and is typically less expensive.

### 4.2.3 Structural Assessment

The team has conducted preliminary consideration of the structural integrity of the roof for the installation of the PV array. The City of Toronto provides guidance for the assessment of solar installations [26]. Based on this guidance, the roof is structurally suitable for the PV Array. Upon contract award, a more detailed structural evaluation should be conducted. The City of Toronto's requirements for solar system building permits are outlined in **Exhibit 4-10**.

#### Exhibit 4-10: Structural Requirements

Condition	WNC Proposal
Distributed weight less than 5 psf	Rafters and panel weight (for attached system) [25]: 3 psf Panel weight is 48 p/20 sf = 2.4 psf Racking system weight is .6 psf
Maximum point load less than 50 pounds	Each 8 panel array will have an estimated 16 point loads. Point loads between panels will support the weight of one entire panel and one rafter, thus: $(48 + .6(20))/2 = 30$ pounds per point load or under

Most solar systems, combining all modules, racking, and electrical, are about 4 lb per square foot. Structures built after 1970 (the WNC was built in 1997) are designed to support loads of at least 10 kg per square foot or far greater [27] [28].

### 4.3 Three Line Diagram

**Exhibit 4-11** is an electrical schematic for the proposed 5kW PV solar system.

The following is a point by point description of the electrical schematic and its components. A battery and connection to the building's electrical system is not included due to the systems complete connection to the grid through Ontario's microFIT program [13].

The system consists of 2 rows of 8 CS6U – 345M modules. At optimal performance, the panels will produce 5.5 kW<sub>DC</sub>. They were sized as 10% larger than the inverter which will produce an output of 5 kW<sub>AC</sub>. The wiring from the three rows of panels connects through 10A fuses in the combiner box. Simultaneously, a ground wire, connected to the solar racking grounding anchors which are connected to each panel. PV+/PV- wires connect the system and must support up to 20A/420V. A DC disconnect is included as well as wiring to a Watthour meter, breaker, and panel, and ultimately a ground wire to the earth ground. A neutral line, and two other lines carry AC current and must support up to 15A/240V. The meter is specified and purchased by Toronto Hydro as part of Ontario microFIT. AC breakers with 20A breakers are used as per the Fronius IG Plus V 5.0 specification sheet, see **Appendix**.



### Exhibit 4-11: Three Line Diagram of Proposed Solar Energy System

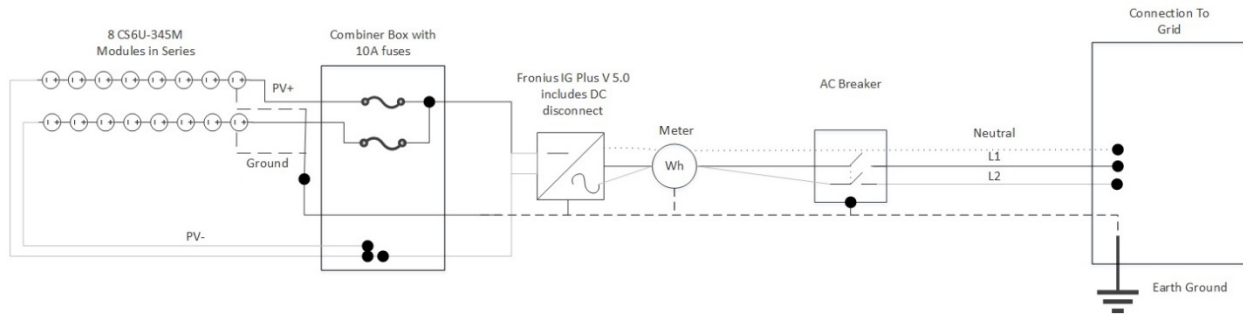

## 4.4 Cost of Proposed Solar Energy System

### 4.4.1 MicroFIT program

Ontario’s microFIT (feed-in-tariff) program accepts PV installations of 6kW or smaller to connect directly into the grid [13]. The program has several requirements noted in various capacities throughout the document. The program incentivizes installations such as these by guaranteeing a return per kWh on energy input into the grid for a 20-year contract.

### 4.4.2 Energy Output

Energy output of the PV system depends on two key factors: azimuth and altitude. To optimize energy output, the solar array will be installed facing due south.

The solar panel array has a two different optimal altitudes depending on the client’s desired maintenance and operational responsibilities throughout the year (**Exhibit 4-12**).

Calculations for optimal angles can be found in the **Appendix** and have been verified using the software RETScreen 4. NLS recommends Option A because Option B produces a marginal increase in output which does not warrant increased operation and maintenance requirements. Moreover, many racking systems do not allow tilt modification.

### Exhibit 4-12: Options for Solar Panel Angle

Option	Description	Angle	Output
A	No adjustments to the PV Array altitude throughout the years	36.2	496 kWh per panel
B	Two adjustments throughout the year to optimize energy output in Summer and Winter.	Summer (March 30 <sup>th</sup> ): 19.5° Winter (Sept 12 <sup>th</sup> ): 57.4°	512 kWh per panel

### 4.4.3 Cost and Return on Investment

**Exhibit 4-13** summarizes the main cost and revenue streams on the installation of 5kW PV array. The Ontario microFIT program is a 20-year contract at 0.311 CAD / kWh, after which energy output is bought at market value.

### Exhibit 4-13: Solar Cost Estimate

Costs		
Capital Costs	Cost (CAD)	Lifespan
Panels [17]	16 x 224.25 = 3588	25
Racking [30]	1750	20
Inverter [22]	2500	10



Costs		
Capital Costs	Cost (CAD)	Lifespan
Installation/Labor [31]	5000	N/A
Hydro Connection	2500	N/A
Government Safety Inspection	500	N/A
Total	15838	
Return		
Ontario microFIT program [31]	0.311/kWh for 496 per year per panel for 16 panels \$2468 per year	

The following chart demonstrates the cash flows for the PV array over a 20 year period. The cash flow calculation takes into consideration revenue from Ontario's microFIT program at a fixed 0.311 CAD/kWh, operation and maintenance costs at 3% of revenue and adjusted for 2% inflation, replacement of the inverter after 10 years, and 1% annual degradation of solar panel output [32]. The payback year is approximately 2024, with a payback period of just over 6 years. The panels are predicted to continue producing energy through to 2043 as per a 25 year lifespan.

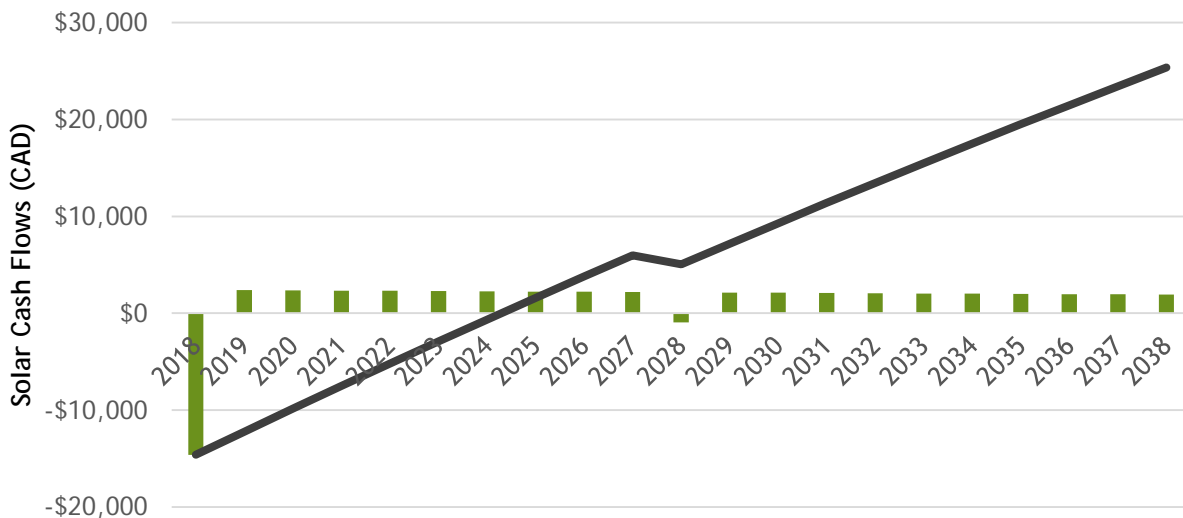

#### 4.4.4 Solar at the WNC

The NLS 5kW solar system proposal will be an innovative addition to a public community centre, providing an education component and allowing the City to strengthen its commitment to a sustainable future. Beyond the financial benefits drawn from participating in the Ontario MicroFit program, the solar installation may be used as an educational tool for the community and children in the attached school. Through live monitoring technology provided by the Fronius inverter, students and community members can directly engage with renewable energy and building retrofit impacts. A station may be set up with data on energy output, solar panels, and installation and operation.

The program will also help the WNC to contribute to the City of Toronto's climate and energy goals. Through the City's programs that support and incentivize building energy retrofits, the project will be a successful addition to the community's, and the City's, movement towards energy efficiency and environmental sustainability.





## 5 Schematic Estimate, Schedule, and Finance Plan

### 5.1 Cost Estimate

A preliminary cost estimate was prepared for the lighting retrofit portion of the project, **Section 3.3**. The two measures with the best payback, LED replacement and motion sensors, were selected. For these measures, a more detailed cost estimate was prepared (**Exhibit 5-1**). Cost data was sourced from equipment manufacturers and the NECA Manual of Labour Units. We also relied on the judgement of industry partners including Black & McDonald.

“General Conditions” includes permits, site equipment, fuel, and other overhead. Labour costs are adjusted based on the complexity of the task. Fixtures which are less accessible or more complicated have higher labour costs to account for the additional time needed for installation.

This preliminary estimate of lighting retrofit cost is \$60,009, representing construction costs only. Grants, incentives, financing, and payback periods are evaluated in **Section 5.4**.

**Exhibit 5-1: Preliminary Lighting Costs**

Item Description	Quantity	Material		Labour		Total
		Material \$/unit	Material Total	Labour \$/unit	Labour Total	
13W LED (T8 Replacement)	261	60	15,660	36	9,396	25,056
Ballast Removal and Disposal	261	-	-	13	3,393	3,393
Fluorescent T8 Disposal	261	5	1,305	-	-	1,305
160 W LED (Gym Light Replacement)	18	468	8,424	183	3,294	11,718
Gym Light Disposal	18	25	450	-	-	450
Motion Sensors	10	25	250	100	1,000	1,250

<b>Project Subtotal</b>		<b>43,172</b>
General Conditions		5,181
Insurance and Liability	3%	1,295
Contingency	10%	4,317
Design Fee	4%	1,727
Overhead and Profit	10%	4,317
<b>Project Total</b>		<b>60,009</b>

A preliminary cost estimate for the Solar Energy System was discussed in **Section 4.4**. Proposed total cost of the system is illustrated in **Exhibit 5-2**. The cost of electricity is set at \$0.20 / kWh for the lighting retrofit as per the RFP and \$0.311 / kWh for the solar energy system in accordance with the microFIT program.

**Exhibit 5-2: Summary of Costs and Benefits**

Item Description	Cost	Annual Electricity Savings / Generation (kWh)	Annual Savings / Revenue	Simple Payback (years)
Lighting Retrofit	\$60,009	58,321	\$11,664	5.1
Solar Energy System	\$15,838	7936	\$2,468	6.4
<b>Project Total</b>	<b>\$75,847</b>	<b>66,257</b>	<b>\$14,132</b>	<b>5.4</b>



## 5.2 Schedule

The total project length is 141 days with retrofit activities commencing on Feb 26, 2018 and concluding on August 3, 2018. This work plan includes both the lighting retrofit and the solar installation. Pre-construction and design will include finalization of the project schedule, detailed engineering design, and contractor selection. Pre-construction and project management can be performed by one electrical engineer.

One of the main priorities for project scheduling is minimizing disruption at the WNC. Many of the rooms have regular weekly activities. In addition, the WNC earns rental income for the larger rooms, including the gym. Based on the client's preferences, mid-winter or mid-summer would be the least disruptive times for the proposed work. To facilitate rooftop solar installation, the on-site work is scheduled for Summer 2018.

Our cost estimate required 65 on-site man-days to complete the lighting retrofit, requiring a crew of 3 electricians 22 work days. Roughly 40% of the existing T8 fixtures are in general areas (e.g. hallways) while 60% are in activity rooms. It will not be necessary to close the WNC entirely while the retrofit is ongoing; instead, individual activity rooms will be closed during the retrofit and reopened when the LED installation is complete.

The 5kW solar system is relatively small, i.e. comparable to a residential system. An experienced installer (subcontracted) could likely complete the on-site work in 4 days, even when considering the added difficulty of working on a three-storey building. Any power shutdowns needed to facilitate solar installation will be scheduled on a weekend.

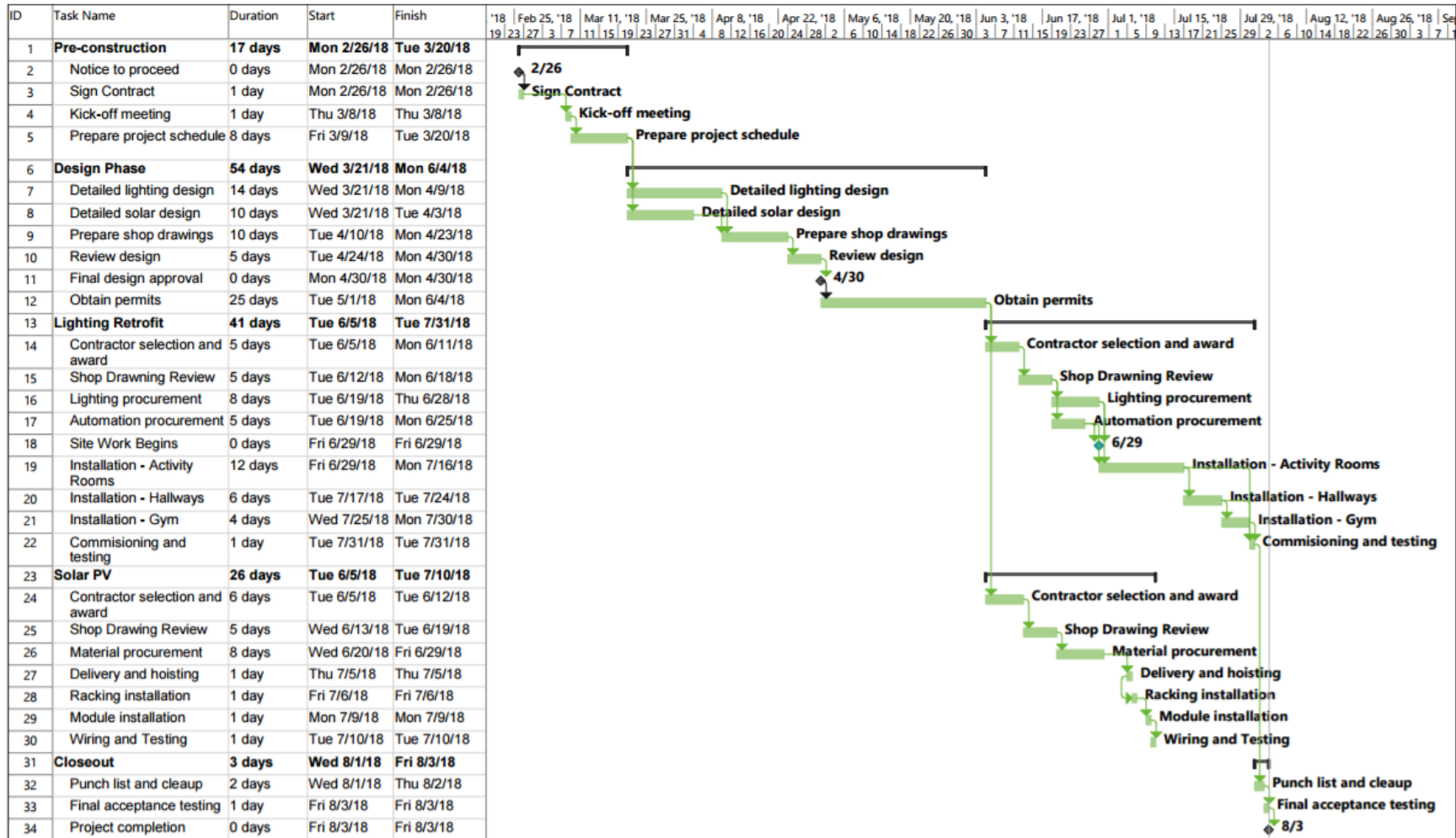



### 5.3 Funding and Incentives

Additional support for the project is available through the Toronto Hydro Retrofit Program and Toronto’s Better Buildings Partnership. These programs have been designed to incentivise energy efficiency and green retrofits.

#### 5.3.1 Toronto Hydro Retrofit Program

The local electricity utility, Toronto Hydro, offers incentives to commercial and institutional customers who are planning energy efficiency projects. For a generic lighting retrofit, Toronto Hydro offers \$0.05 per kWh of annual savings. Savings from lighting controls and other efficiency measures can receive \$0.10 per kWh. If the proposed solution is undertaken there should be a savings of 48,688 kWh from generic lighting retrofit and 9,633 kWh from motion sensors. This would result in \$3,398 available in incentives.

#### 5.3.2 City of Toronto Better Buildings Partnership

To help buildings achieve better energy performance and reduce their environmental impact, the City of Toronto offers resources to the industry including knowledge, technical analysis, and financing. Through this program, the WNC retrofit would be eligible for a low-interest loan at the City’s borrowing rate. Based on recent municipal bonds, we have estimated this rate to be 3.1%.

### 5.4 Cash Flow and Finance

The project is expected to deliver electricity bill savings of \$11,664 and solar revenues of \$2,468 in its first year. Using the project cost from **Section 5.1** and incentives from **Section 5.3**, the simple payback is 5.4 years as shown in **Exhibit 5-2**.

**Exhibit 5-3: Cash Flow Without Financing**

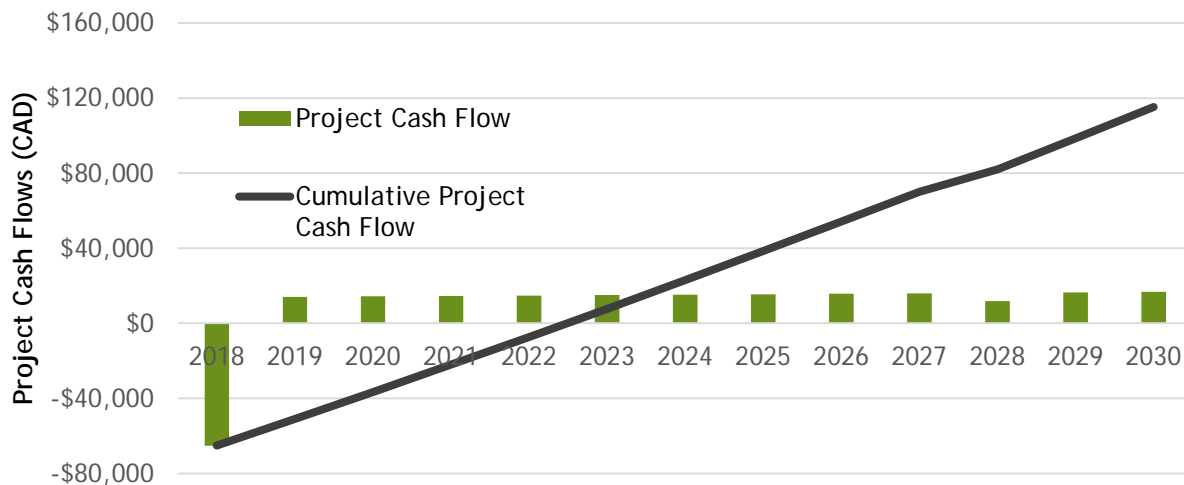

NLS believes that bill savings represent a conservative estimate of the project’s value; the retrofit is also expected to improve lighting quality throughout the building and reduce maintenance costs.

With an initial debt financing of \$78,000, WNC would not need to provide any cash up front to proceed with the project. The loan could be paid off completely in 7 years using only bill savings and revenue from the solar panels, as illustrated in **Exhibit 5-5**.



**Exhibit 5-4: Cash flow with Financing at 3.1% Interest**

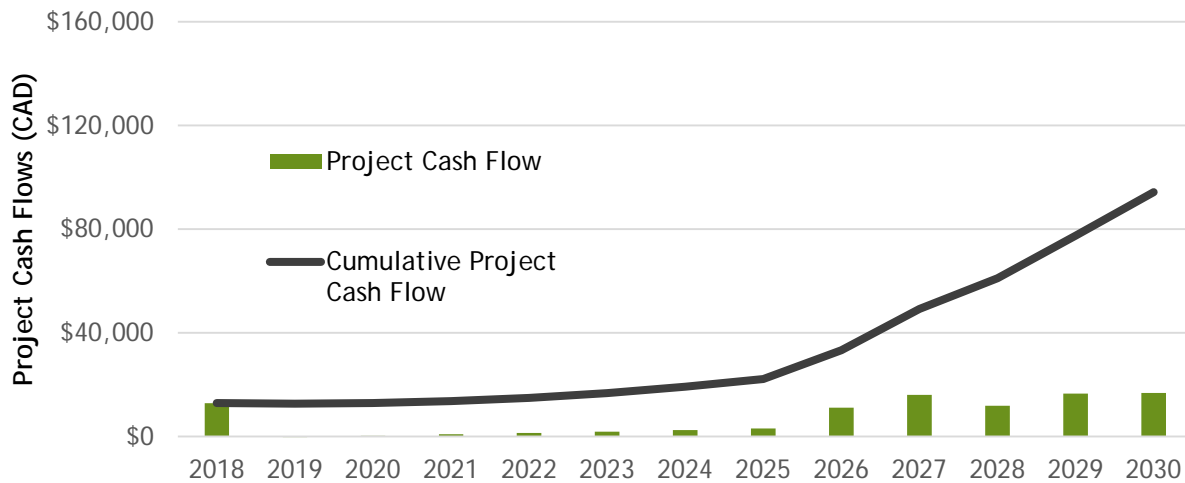

Annual operations and maintenance for the project are estimated at \$438 / year on average. All components of the project are expected to have a lifetime of at least 20 years before requiring replacement with the exception of the inverter and racking system for the solar energy system, which have a lifetime of 10 years. This replacement, estimated at \$4,300, accounts for the reduced cash flow in 2028. Energy prices are assumed to escalate with 2% inflation. All figures are presented in nominal Canadian dollars.

## 6 Outreach

Throughout project development, NLS has engaged in outreach activities to increase the visibility of energy issues. Through targeted activities at the community centre and at the University of Toronto, we have shared specific knowledge of sustainable buildings and energy efficiency. NLS has collaborated extensively with our local CECA / NECA chapter to improve our technical analysis and help to engage the electrical contracting industry in energy conservation efforts.

### 6.1 Energy Awareness and Community Outreach

#### 6.1.1 NLS Blog

In order to improve awareness of CECA UofT's work and to attract a larger audience, the team decided to revamp the club's website ([cecauoft.wordpress.com](http://cecauoft.wordpress.com)), illustrated in Exhibit. The design of the website was fully revised and focused on posting short but interesting articles that would attract readers to learn more about CECA UofT. These posts could then be shared to other social media websites to reach an even wider audience.



## Exhibit 6-1: CECA / NECA UofT Blog

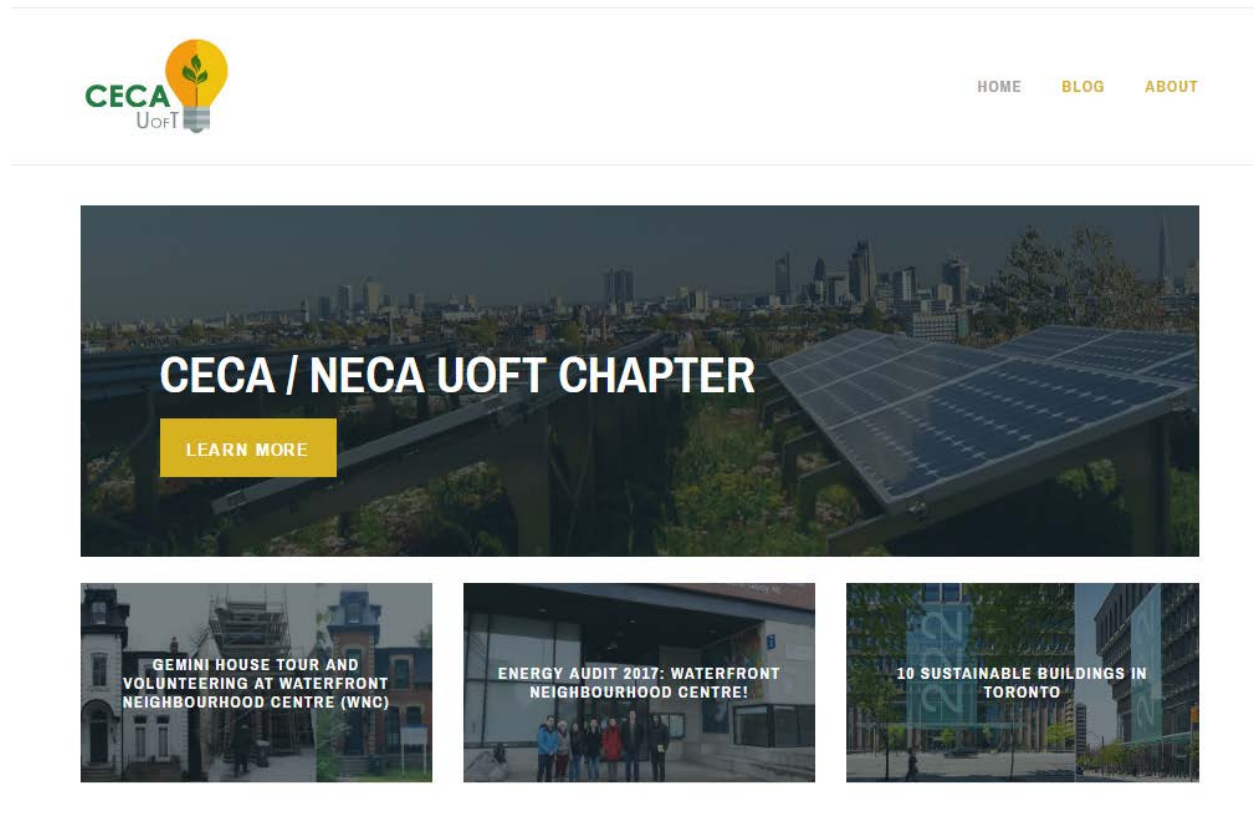

### Recent Posts

[MORE POSTS](#) —

APRIL 23, 2017 | [2017 GREEN ENERGY CHALLENGE, BLOG](#)

#### [Gemini House Tour and Volunteering at Waterfront Neighbourhood Centre \(WNC\)](#)

The blog's first post was created prior to the Green Energy challenge and focused on sustainable buildings found in Toronto. This post provided the team with ideas and inspiration for the green energy challenge, as the post discussed many existing buildings that had undergone renovations and sustainable retrofitting.

The blog's second post was made once the team selected the WNC for the Green Energy Challenge. This post focussed mostly on the Energy Audit conducted at the WNC. The goal of the post was to introduce the building to our readers and provide a summary of all tasks involved with the Energy Audit.

The blog's third post focused on outreach initiatives such as a sustainable building tour that the club hosted, and volunteering that was done at the WNC. The goal of this post was to inform readers on how the club was spreading awareness on the importance of sustainable buildings, and how the club was getting involved in the WNC's community.

All of the blog posts and updates were also shared through the CECA UofT Chapter Facebook page. The posts have gathered the audience of about 700 Facebook users. The team plans to continue to use and update the website throughout the year, as well as



maintain a social media presence as they host more events and receive further updates on the Green Energy Challenge.

### 6.1.2 University of Toronto Sustainability Conference

Every year the University of Toronto Sustainable Engineers' Association holds a conference to bring experts from all areas of sustainability for a daylong event. Speakers include experienced members of the industry and cutting edge researchers. As part of the conference, student groups who work on sustainable projects are invited to share their activities.

The University of Toronto CECA / NECA student chapter set up a booth to display their experience with the previous two years of the ELECTRI Green Energy Challenge, as seen in **Exhibit 6-4**. This served as an excellent opportunity to engage like-minded individuals, share knowledge, and recruit new members.

**Exhibit 6-2: NLS at UofT's Sustainability Conference**

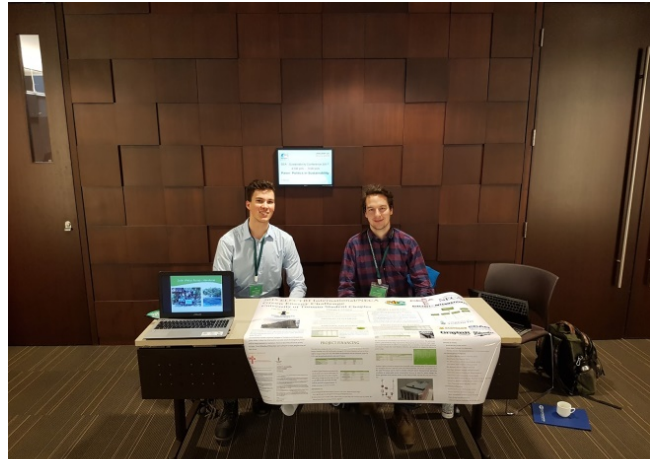

### 6.1.3 Gemini House Tour

This year, NLS had a focus on engaging with the student body at the University of Toronto, as well. The team arranged for a tour of a low-energy home, named "Gemini House", which was a project led by University of Toronto and Ryerson University. This project included the retrofit of a 1880s masonry home using the application of GEMINI NTED™. Using this methodology, the building was thermally isolated into two zones: core and periphery zones. The "core" zones are the more frequently used rooms requiring constant heating/cooling; the periphery zones are the less used rooms with heating/cooling controlled based on demand.

**Exhibit 6-3: Tour at the Gemini House**



This innovative project was carried out by a professor within the University of Toronto Civil Engineering Department, Professor Kim Pressnail. The team co-ordinated with his availability and arranged for him to lead the tour, shown in **Exhibit 6-5**. The event was set up through Facebook as well as through a ticketing system via Eventbrite. The event was sold out with more than 20 student attendees who came for the hour-long tour. The purpose of the tour was to engage students in the community and to get them to start thinking about innovative ways to reduce energy used in homes. The turnout and overall energy of the students during the event showcased success of the intended purpose. The team plans



to host more events like these in the future to engage more students onto the exciting field of sustainable buildings.

### 6.1.4 Interaction with the City of Toronto

As the City of Toronto provides critical funding to this organization and is responsible for WNC's maintenance, NLS decided it would be invaluable to get their input on the project. To do this NLS submitted a draft of our proposal to the City of Toronto Renewable Energy Office and then gave them a presentation along with two staff from WNC. This presentation led to a great discussion where NLS was able to get a better understanding of what both WNC as well as the City desire from a project like this. With this feedback NLS was able to develop a better and stronger final proposal.

## 6.2 Feedback Letters and Documentation of Volunteer Efforts

### 6.2.1 Volunteering at Waterfront Neighbourhood Centre

NLS planned and delivered two workshops for WNC to improve awareness of energy and sustainability issues. The project team developed educational materials and activities for each workshop to tailor the material to the intended audience.

The first workshop, a primer on green buildings and climate change, was directed at young children and built on WNC's After 4 Youth Program. Many of the participants had never heard of climate change or the role of an individual's energy consumption choices on global sustainability so therefore, leading a workshop was an attempt to get younger children to start thinking earlier about these topics.

With the help of WNC staff and University of Toronto Faculty, NLS created activities which would demonstrate simple energy efficiency concepts. As part of this collaboration NLS prepared a lesson plan and provided it to WNC staff two days before the event. For one of the lessons, participants were invited to compare the heat generation of the three main home lighting technologies (i.e. incandescent, CFL, and LED) using a surface temperature sensor as seen in **Exhibit 6-1**. Using knowledge from the workshop, the children were able to design their own sustainable homes.

**Exhibit 6-4: NLS Teaching Children About Lighting Efficiency**

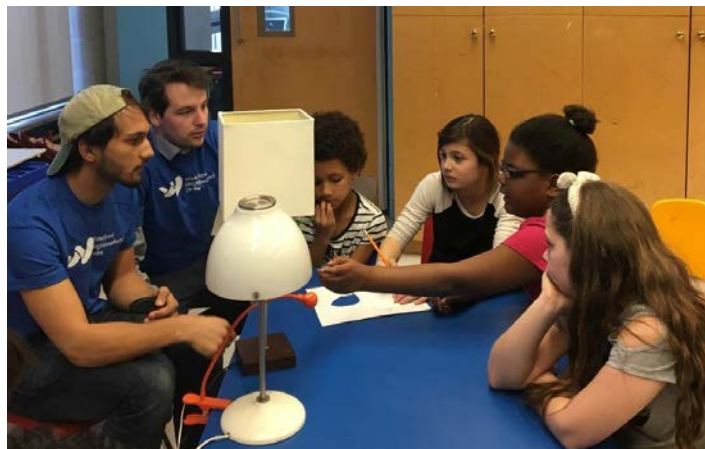

Students were clearly excited by this hands-on demonstration and were eager to assess surface temperatures throughout the room. For one of the students in particular, the lesson really hit home when they asked how an LED light produce brighter light while using less





energy than an incandescent light. This led to excellent teaching moment where NLS explained that LEDs represent a significant improvement in technology.

**Exhibit 6-5: NLS Engaged in Earth Day Event**



The second workshop was created as the request of WNC as part of their Earth Day event, shown in **Exhibit 6-2**. NLS created a guide to help a senior's group at WNC manage their electricity bills using energy efficiency. NLS presented an overview of the work that was being planned as part of the Green Energy Challenge and discussed how similar strategies could be applied at the household level.

Participants were very responsive to the cost-saving strategies discussed and the utility incentives that are available for energy efficiency. This was particularly true as most of the attendants were on fixed incomes and

had to pay sharply increasing utility bills. WNC even requested further documentation of the strategies to share with other community members.

### 6.2.2 Volunteering Hours

As attributed in 7.1.1, NLS had a large focus on providing community service to WNC through educational workshops. As shown in **Exhibit 6-6**, the team spent approximately 48 volunteer hours planning and executing the two big community service educational workshops.

The presentation and preparation for the After 4 Youth program workshop was a collective effort of six members of the team. The team spent a total of six individual hours preparing final plans for activities days prior to the event. The same six individuals were all present to lead the final hour-long workshop.

The second event referenced was the Earth Day event for seniors in the community. The preparation of the event including the presentation was approximately two hours per person with the event being an hour-long session. It was led by two NLS members with contribution of others team members offline.

**Exhibit 6-6: Volunteer Hours Contributed by NLS**

Event	Preparation (person hours)	Final event (person hours)	Total (person hours)
After 4 Program youth event	36	6	42
Seniors Earth Day event	4	2	6
<b>TOTAL</b>			<b>48</b>

### 6.2.3 Feedback Letters

One of the two feedback letters from WNC, which highlights NLS outreach component, is provided below. Three other feedback letters, another from WNC, one from CECA, and one from the City of Toronto, are located in the **Appendix**.



April 24, 2017

Formerly Harbourfront Community Centre

Green Energy Challenge 2017 - Northern Lights Solutions  
CECA/NECA University of Toronto Student Chapter  
Room GB 314, Galbraith Building  
Department of Civil Engineering  
University of Toronto  
35 St. George Street, Toronto, ON M5S 1A4

Re: Waterfront Neighbourhood Centre - Green Energy Challenge 2017

Dear Team:

On behalf of the Board of Management and Staff team of the Waterfront Neighbourhood Centre, I would like to extend my gratitude for your volunteer time with HCC Community Garden project this past spring. I am writing to thank you for choosing the Waterfront Neighbourhood Centre as your building for the Green Energy Challenge. Your dedication in working with us as well as your enthusiasm in volunteering your time to help with the services that we provide are much appreciated.

Your team recognized that educating the community is a great service and an effective method to spread awareness about the importance of being energy efficient. I had the opportunity to watch your team lead an interactive workshop for children of ages 6-12 with our "After 4 Program". The children were highly engaged as they learned about sustainable design and ways in which they could make energy efficient improvements in their homes. I was very impressed with your team's readiness in preparing a plan for the workshop and allowing myself and the program manager to review it for feedback prior to hosting the activity. Thank you for all of your hard work in hosting the workshops and understanding the impact that education can have for young children.

In addition, I also wanted to thank you for choosing to be a part of WNC's Senior's Earth Day Program. We have a big group of seniors in our community who are paying large energy bills as they do not have an understanding on how hydro and energy usage is tabulated. Your team's presentation on government energy use tracking and ways in which one can make energy efficient decisions to cut back on the bills directly addressed this gap. This presentation was a valuable learning experience and integrated well within the existing activities planned for the Earth Day event.

On behalf of myself and WNC's Children and Community Development program managers, I give full support to your team's success for the Green Energy Challenge 2017. I wish you a great success and thank you for volunteering your time in educating the community about the importance of energy conservation.

Sincerely,

A handwritten signature in black ink that reads 'Suada Warsame'.

Suada Warsame  
Manager, Business, Information and Volunteer Services

627 Queens Quay West, Toronto, Ontario M5V 3G3  
Tel. 416.392.1509 Fax 416.392.1512  
www.waterfrontnc.ca

## 6.3 Article in Department / University Newsletter

### The 2017 U of T CECA/NECA Team Seeks to Best their 2016 Top Three Finalist Honours



The University of Toronto student chapter of the Canadian/National Electrical Contractors Association (CECA/NECA) is preparing to once again compete in the annual ELECT International's Green Energy Challenge where last year they were one of three finalists and the only Canadian university participating in the final round in Boston. This year they are hoping to walk away with top honours.



## 6.4 CECA / NECA Chapter Interaction

This year NLS has continued to expand their connection with our partner CECA chapter. As a relatively new organization, NLS has prioritized building connections in the electrical contracting industry and strengthening the old ones. The Canadian Electrical Contractors' Association (CECA) remains our primary point of contact with the industry. NLS have maintained regular email communication in-person meetings with both David Mason and Gary Fitzpatrick, the President and Treasurer of CECA. Both Mr. Mason and Mr. Fitzpatrick have also helped provide feedback on all of our submissions including the Student Passport Initiative and the ELECTRI Green Energy Challenge.

In order to increase collaboration with local contractors, NLS connected with Robert O'Donnell, Executive Vice-President of the Greater Toronto Electrical Contractors Association. Mr. O'Donnell has also provided technical feedback for our participation in the Student Passport Initiative and the ELECTRI Green Energy Challenge. NLS even utilized one of their meetings with Mr. Mason, Mr Fitzpatrick, and Mr. O'Donnell to give a presentation on their Student Passport Initiative proposal. This provided an even greater dialogue on the benefits of the NLS proposal as well as opportunity to discuss ways to further improve it.

NLS sought technical advice from other local contractors to support our work. In particular Larry Tricinci of Beacon Utility proved of incredible importance to developing NSL's Student Passport Initiative Proposal. Other contractors that were engaged in this project are mentioned in the Acknowledgements.

During their 2015 ELECTRI Green Energy Challenge NLS partnered with Good Shepherd Ministries to propose an energy retrofit of their facility. Good Shepherd Ministries, is a homeless shelter in Toronto located on Queen Street that on a typical day serves 1,200 meals and fills all 91 of their beds. [35] Local contractors were so impressed with NLS's proposal and saw significant benefit from undertaking the suggestions outlined in the proposal that they decided to undertake the project and support in any way they could.

Since the proposal was submitted NLS attended the kick-off meeting where they took meeting minutes and thereafter wrote an article for the Daily Commercial News to help get more contractors involved. To date the lighting retrofit has been undertaken with significant support from Bob Ritzman, President of Alltrade Industrial, who was the Project Manager overseeing construction as well as Robert O'Donnell who committed the Greater Toronto Electrical Contractors Association to donate \$30,000 towards the project. This project has not only reaffirmed the value of the work that NLS has completed to date but strengthen our connection with local contractors.



## Works Cited

- [1] Waterfront Neighbourhood Centre, "Harbourfront Community Centre 2015 Annual Report," Toronto, 2015.
- [2] J. Rousseau, "Development of Design Procedures and Guidelines for Reducing Electric Demand," Canadian Housing Information Centre, 1991.
- [3] "Variable Frequency Drives," Toronto Hydro, [Online]. Available: <http://www.torontohydro.com/sites/electricsystem/electricityconservation/businessconservation/pages/variablefrequencydrives.aspx>. [Accessed 30 April 2017].
- [4] P. Evan Mills, "A Golden Opportunity for Reducing Energy Costs and Greenhouse Gas Emissions," California Energy Commission Public Interest Energy Research, Berkeley, CA, 2009.
- [5] "Energy-saving Strategies for Water-source Heat Pumping Systems," *Trane Engineers Newsletter*, Vols. 36-2, pp. 1-8, 2007.
- [6] Hydro Quebec, "Devices Drawing Standby Load (Phantom Power)," Hydro Quebec, [Online]. Available: <http://www.hydroquebec.com/residential/energy-wise/how/energy-efficient-products/appliances-devices/phantom-power.html>. [Accessed 30 April 2017].
- [7] archtoolbox, "Recommended Lighting Levels in Buildings," [Online]. Available: <https://www.archtoolbox.com/materials-systems/electrical/recommended-lighting-levels-in-buildings.html>. [Accessed 28 April 2017].
- [8] D. Wulfinghoff, "Control and Use of Sunlight," in *Energy Efficiency Manual*, 1999, pp. 100--1005.
- [9] "Philips 281576 - F32T8/TL741/ALTO," 1000 Bulbs, [Online]. Available: <https://www.1000bulbs.com/product/85821/PHILIPS-281576.html>. [Accessed 30 April 2017].
- [10] "LED Tube - 3 ft. T8 Replacement - 5000 Kelvin," 1000 Bulbs, [Online]. Available: <https://www.1000bulbs.com/product/175322/PLT-10367.html>. [Accessed 30 April 2017].
- [11] G. a. K. Hamilton, "Cost to Install a Motion Sensing Switch," Do It Yourself or Not, [Online]. Available: <http://www.diyornot.com/Project.aspx?ndx2=4&Rcd=240>. [Accessed 30 April 2017].
- [12] "Motion Sensor Lights Cost," Cost Helper Home & Garden, [Online]. Available: <http://home.costhelper.com/motion-sensor-lights.html>. [Accessed 30 April 2017].
- [13] Pilkington, "Pilkington Activ™ Self-Cleaning Glass, Frequently Asked Questions: Consumer," [Online]. Available: <http://www.pilkington.com/resources/faqconsumer.pdf>. [Accessed 30 April 2017].
- [14] "Pilkington Activ (Blue/Bronze)," Pilkington, [Online]. Available: <https://www.pilkington.com/en-gb/products/product-categories/self-cleaning/pilkington-activ-range/pilkington-activ-blue-bronze>. [Accessed 30 April 2017].
- [15] Independent Electricity System Operator, "microFIT Program," 1 January 2017. [Online]. Available: <http://www.ieso.ca/get-involved/microfit/program-documents>. [Accessed 20 04 2017].
- [16] City of Toronto Community Planning, "Bathurst Quay Neighbourhood Plan," City of Toronto, 2017. [Online]. Available: <http://www1.toronto.ca/wps/portal/contentonly?vgnextoid=d7ea37130161a410VgnVCM10000071d60f89RCRD>. [Accessed 15 04 2017].
- [17] EnergyMatters, "Choosing The Best Solar Panel," [Online]. Available: <http://www.energymatters.com.au/panels-modules/choosing-solar-panels/>. [Accessed 15 March 2017].
- [18] Solar Panels Exposed, "Types of Solar Panels – Discover the Pros and Cons of the Most Used PV Solar Panels," [Online]. Available: <http://solarpanelsvenue.com/types-of-solar-panels-most-used-pv-solar-panels/>. [Accessed 20 March 2017].
- [19] CivicSolar, "Canadian Solar Quatech MaxPower CS6X-315P 315W Poly SLV/WHT 1000V Solar Panel," [Online]. Available: <https://www.civicsolar.com/product/canadian-solar-quatech-maxpower-cs6x-315p-315w-poly-slvwht-1000v-solar-panel>. [Accessed 20 March 2017].
- [20] CivicSolar, "Canadian Solar CS6U-345M 345W Mono Quintech SLV/WHT Solar Panel 5BB," [Online]. Available: <https://www.civicsolar.com/product/canadian-solar-cs6u-345m-345w-mono-quintech-slvwht-solar-panel-5bb>. [Accessed 20 March 2017].
- [21] Heliene Inc., "Heliene Photovoltaic Modules," 2012. [Online]. Available: <https://cdn.enfsolar.com/Product/pdf/Crystalline/520199d5aa2fb.pdf>. [Accessed 23 March 2017].
- [22] GrapeSolar, "Panels," [Online]. Available: <http://www.grapesolar.com/panels.html>. [Accessed 24 March 2017].



- [23] Hanwha Solar, "HSL 60 | Poly," 26 September 2013. [Online]. Available: <http://hespv.ca/hesproductspecs/Hanwha/HanwhaHSL255.pdf>. [Accessed 24 March 2017].
- [24] A. Sendy, "Pros and Cons of String Inverters vs. Micro Inverters," 7 April 2016. [Online]. Available: <https://www.solarreviews.com/solar-inverters/pros-and-cons-of-string-inverter-vs-microinverter/#advantagesStringInverters>. [Accessed 30 March 2017].
- [25] Fronius USA LLC, "Fronius IG Plus V 5.0-1 UNI / 6.0-1 UNI / 7.5-1 UNI," [Online]. Available: [http://www.fronius.com/cps/rde/xchg/SID-2E33EF1A-38CF3FEF/fronius\\_usa/hs.xsl/2714\\_1481.htm#.WQcVFXYv4Y](http://www.fronius.com/cps/rde/xchg/SID-2E33EF1A-38CF3FEF/fronius_usa/hs.xsl/2714_1481.htm#.WQcVFXYv4Y). [Accessed 30 March 2017].
- [26] energysage, "String inverters vs. Microinverters vs. Power optimizers," [Online]. Available: <https://www.energysage.com/solar/101/string-inverters-microinverters-power-optimizers/>. [Accessed 30 March 2017].
- [27] Affordable Solar, "CALCULATING TILTED ARRAY SPACING," [Online]. Available: <http://www.affordable-solar.com/learning-center/building-a-system/calculating-tilted-array-spacing/>. [Accessed 25 April 2017].
- [28] R. Mayfield, "Flat Roof Mounting Systems," SolarPro, 01 February 2009. [Online]. Available: <http://solarprofessional.com/articles/products-equipment/racking/flat-roof-mounting-systems>. [Accessed 28 February 2017].
- [29] S. Busong, "Advantages and disadvantages of a solar tracker system," 6 May 2016. [Online]. Available: <http://www.solarpowerworldonline.com/2016/05/advantages-disadvantages-solar-tracker-system/>. [Accessed 20 April 2017].
- [30] City of Toronto, "A Guide to Requirements for Building Permits for Solar Systems," 25 October 2010. [Online]. Available: [https://www1.toronto.ca/static\\_files/GuideBuildingPermitRequirementsSolar-Oct-10.pdf](https://www1.toronto.ca/static_files/GuideBuildingPermitRequirementsSolar-Oct-10.pdf). [Accessed 30 March 2017].
- [31] National Research Council Canada, "Snow loads - when to shovel your roof," 26 January 2017. [Online]. Available: [http://www.nrc-cnrc.gc.ca/eng/solutions/advisory/codes\\_centre/faq/snow\\_loads.html#Q4](http://www.nrc-cnrc.gc.ca/eng/solutions/advisory/codes_centre/faq/snow_loads.html#Q4). [Accessed 18 April 2017].
- [32] A. Diehl, "Roof Load Considerations for PV Arrays," CivicSolar, 01 June 2015. [Online]. Available: <https://www.civicsolar.com/support/installer/articles/roof-load-considerations-pv-arrays>. [Accessed 02 March 2017].
- [33] L. Bas, "Solar PV Racking Options - Comparison Chart," CivicSolar, November 2010. [Online]. Available: <https://www.civicsolar.com/support/installer/articles/solar-pv-racking-options-comparison-chart>. [Accessed 18 April 2017].
- [34] rimstar, "Ontario's MicroFIT/FIT Feed-in Tariff incentive programs," [Online]. Available: [http://rimstar.org/renewnrg/ontario\\_microfit\\_feed\\_in\\_tariff.htm](http://rimstar.org/renewnrg/ontario_microfit_feed_in_tariff.htm). [Accessed 10 April 2017].
- [35] T. Lombardo, "What is the Lifespan of a Solar Panel," 20 April 2014. [Online]. Available: <http://www.engineering.com/ElectronicsDesign/ElectronicsDesignArticles/ArticleID/7475/What-Is-the-Lifespan-of-a-Solar-Panel.aspx>. [Accessed 28 April 2017].
- [36] "Programs & Services," Good Shepherd Ministries, 2015. [Online]. Available: <http://www.goodshepherd.ca/programs-services/good-shepherd-centre>. [Accessed 30 April 2017].
- [37] Y. Z. L. D. Y. a. J. Z. Zhang, "Analysis of Thermal Performance and Energy Savings of Membrane Based Heat Recovery Ventilators," Energy, 2000.



## Appendix

### Acknowledgements

Northern Lights Solutions would like to thank the following individuals for their support and assistance throughout the project:

#### University of Toronto

- Brenda McCabe, Professor, Civil Engineering, Faculty Advisor to Student Chapter
- Marianne Touchie, Professor, Civil Engineering
- Kim Pressnail, Professor, Civil Engineering

#### CECA & Industry Partners

- David Mason, President, CECA
- Garry Fitzpatrick, Treasurer, CECA
- Robert O'Donnell, Executive Vice-President, Greater Toronto Electrical Contractors Association
- Douglas Randall, Black & McDonald (Sales and Business Development)
- Erica Brabon, Black & McDonald (Manager, Energy and Sustainability)
- Angelo Suntres, Black & McDonald (Chief Estimator ICI Mechanical)

#### Waterfront Neighbourhood Centre

- Leona Rodall, Executive Director, Waterfront Neighbourhood Centre
- Kelly McClure, Assistant Executive Director, Waterfront Neighbourhood Centre
- Oriel Boothe, Manager - Facility Operations, Waterfront Neighbourhood Centre
- Gaby Motta, Manager - Community Development & Seniors Programs, Waterfront Neighbourhood Centre
- Suada Warsame, Manager - Business & Information Technology & Volunteer Resources, Waterfront Neighbourhood Centre
- Elizabeth Carrillo, Seniors Program Worker, Waterfront Neighbourhood Centre

#### City of Toronto Staff

- Robert Maxwell, Manager, Toronto Renewable Energy Office, City of Toronto
- Dejan Skoric, Senior Energy Consultant, Toronto Renewable Energy Office, City of Toronto
- Elena Gruia, Project Manager, Toronto Renewable Energy Office, City of Toronto



## Panel and Inverter Specifications

The following are detailed specifications for the team's recommended panel and inverter.

### ENGINEERING DRAWING (mm)

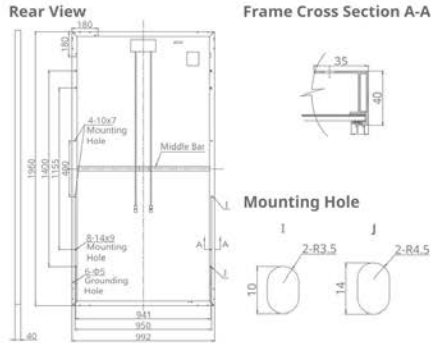

### ELECTRICAL DATA / STC\*

CS6U	330M	335M	340M	345M
Nominal Max. Power (Pmax)	330 W	335 W	340 W	345 W
Opt. Operating Voltage (Vmp)	37.5 V	37.8 V	37.9 V	38.1 V
Opt. Operating Current (Imp)	8.80 A	8.87 A	8.97 A	9.06 A
Open Circuit Voltage (Voc)	45.9 V	46.1 V	46.2 V	46.4 V
Short Circuit Current (Isc)	9.31 A	9.41 A	9.48 A	9.56 A
Module Efficiency	16.97%	17.23%	17.49%	17.74%
Operating Temperature	-40°C ~ +85°C			
Max. System Voltage	1500 V (IEC) or 1500 V (UL)			
Module Fire Performance	TYPE 1 (UL 1703) or CLASS C (IEC 61730)			
Max. Series Fuse Rating	15 A			
Application Classification	Class A			
Power Tolerance	0 ~ + 5 W			

\* Under Standard Test Conditions (STC) of irradiance of 1000 W/m<sup>2</sup>, spectrum AM 1.5 and cell temperature of 25°C.

### ELECTRICAL DATA / NOCT\*

CS6U	330M	335M	340M	345M
Nominal Max. Power (Pmax)	238 W	242 W	245 W	249 W
Opt. Operating Voltage (Vmp)	34.2 V	34.5 V	34.6 V	34.7 V
Opt. Operating Current (Imp)	6.96 A	7.01 A	7.10 A	7.17 A
Open Circuit Voltage (Voc)	42.1 V	42.3 V	42.4 V	42.6 V
Short Circuit Current (Isc)	7.54 A	7.62 A	7.67 A	7.74 A

\* Under Nominal Operating Cell Temperature (NOCT), irradiance of 800 W/m<sup>2</sup>, spectrum AM 1.5, ambient temperature 20°C, wind speed 1 m/s.

### PERFORMANCE AT LOW IRRADIANCE

Outstanding performance at low irradiance, average relative efficiency of 96.5 % from an irradiance of 1000 W/m<sup>2</sup> to 200 W/m<sup>2</sup> (AM 1.5, 25°C).

The specification and key features described in this datasheet may deviate slightly and are not guaranteed. Due to on-going innovation, research and product enhancement, Canadian Solar Inc. reserves the right to make any adjustment to the information described herein at any time without notice. Please always obtain the most recent version of the datasheet which shall be duly incorporated into the binding contract made by the parties governing all transactions related to the purchase and sale of the products described herein.

Caution: For professional use only. The installation and handling of PV modules requires professional skills and should only be performed by qualified professionals. Please read the safety and installation instructions before using the modules.

### CS6U-335M / I-V CURVES

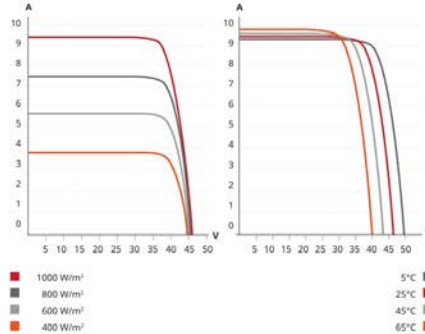

### MECHANICAL DATA

Specification	Data
Cell Type	Mono-crystalline, 6 inch
Cell Arrangement	72 (6×12)
Dimensions	1960×992×40 mm (77.2×39.1×1.57 in)
Weight	22.4 kg (49.4 lbs)
Front Cover	3.2 mm tempered glass
Frame Material	Anodized aluminium alloy
J-Box	IP67, 3 diodes
Cable	PV1500DC-F1 4 mm <sup>2</sup> (IEC) & 12 AWG 2000 V (UL), 1160 mm (45.7 in)
Connector	T4 (IEC/UL)
Per Pallet	26 pieces, 635 kg (1400 lbs)
Per container (40' HQ)	624 pieces

### TEMPERATURE CHARACTERISTICS

Specification	Data
Temperature Coefficient (Pmax)	-0.41 % / °C
Temperature Coefficient (Voc)	-0.31 % / °C
Temperature Coefficient (Isc)	0.053 % / °C
Nominal Operating Cell Temperature	45±2 °C

### PARTNER SECTION





If you use this site, you agree to our use of cookies. More information  
**FRONIUS CANADA**



## Fronius IG Plus Advanced 5.0-1 UNI / 6.0-1 UNI / 7.5-1 UNI



### Integrated arc fault protection.

The Fronius IG Plus Advanced is the next generation of the renowned Fronius IG Plus series. One of the first CSA-certified inverter lines with integrated arc fault protection available in Canada, the Fronius IG Plus Advanced offers a safe and cost-effective one-box solution to the new Canadian Electric Code AFCI requirements. It also comes equipped with a built-in Fronius Com Card for easier and faster monitoring installations in the field.

*\*In Canada, the Fronius IG Plus Advanced is available both Ontario domestic content compliant (DCC) and non-domestic content compliant.*

### Technical Data

Input data	5.0-1 UNI	6.0-1 UNI	7.5-1 UNI
Recommended PV power (kWp)	4.25 - 5.75	5.10 - 6.90	6.35 - 8.60
MPPPT voltage range	230 - 500 V	230 - 500 V	230 - 500 V
Max. input voltage range (at 1000 W/m <sup>2</sup> 14 F (-10 C) in open circuit operation)	600 V	600 V	600 V
Nominal input current	13.8 A	15.6 A	20.7 A
Max. usable input current	23.4 A	28.1 A	35.1 A
Admissible conductor size (DC)	No. 14-6 AWG	No. 14-6 AWG	No. 14-6 AWG
Output data	5.0-1 UNI	6.0-1 UNI	7.5-1 UNI
Nominal output power (PAC nom)	5,000 W	6,000 W	7,500 W
Max. continuous output power 104 F (40 C) 208 V / 240 V / 277 V	5,000 W	6,000 W	7,500 W
Nominal AC output voltage	208 V / 240 V / 277 V	208 V / 240 V / 277 V	208 V / 240 V / 277 V
Operating AC voltage range (default)	183 - 229 V (-12 / 10%) 211 - 264 V (-12 / 10%) 240 V (10%) 277 V (10%)	183 - 229 V (-12 / 10%) 211 - 264 V (-12 / 10%) 240 V (10%) 277 V (10%)	183 - 229 V (-12 / 10%) 211 - 264 V (-12 / 10%) 240 V (10%) 277 V (10%)
Maximum continuous output current	24.0 A 20.8 A 18.1 A	28.8 A 25.0 A 21.7 A	38.1 A 31.3 A 27.1 A
Admissible conductor size (AC)	No. 14 - 4 AWG	No. 14 - 4 AWG	No. 14 - 4 AWG
Max. continuous utility back feed current	0 A	0 A	0 A
Nominal frequency	60 Hz	60 Hz	60 Hz
Operating frequency range	59.3 - 60.5 Hz	59.3 - 60.5 Hz	59.3 - 60.5 Hz
Total harmonic distortion	< 3%	< 3%	< 3%
Power factor	1	1	1
General data	5.0-1 UNI	6.0-1 UNI	7.5-1 UNI
Max. efficiency	96.2%	96.2%	96.2%
CEC Efficiency	95.5% 95.5% 96.0%	95.5% 95.0% 95.0%	95.5% 96.0% 96.0%
MPP adaption efficiency	> 99.9%	> 99.9%	> 99.9%
Consumption in standby mode (at night)	< 1 W	< 1 W	< 1 W
Consumption during operation	15 W	15 W	15 W
Cooling	Controlled forced ventilation, variable speed fan	Controlled forced ventilation, variable speed fan	Controlled forced ventilation, variable speed fan
Enclosure Type	NEMA 3R	NEMA 3R	NEMA 3R
Unit Dimensions (W x H x D)	17.1 x 36.5 x 9.6 in.	17.1 x 36.5 x 9.6 in.	17.1 x 36.5 x 9.6 in.
Power stage weight	57 lbs. (26 kg)	57 lbs. (26 kg)	57 lbs. (26 kg)
Wiring compartment weight (C box)	24 lbs. (11 kg)	24 lbs. (11 kg)	24 lbs. (11 kg)
Admissible ambient operating temperature	-13 to 131 F (-25 to 55 C)	-13 to 131 F (-25 to 55 C)	-13 to 131 F (-25 to 55 C)
Admissible ambient storage temperature	-40 to 131 F (-40 to 55 C)	-40 to 131 F (-40 to 55 C)	-40 to 131 F (-40 to 55 C)
Compliance	UL 1741-2010, IEEE 1547-2003, IEEE 1547.1, UL 1699B-2013, ANSI/IEEE C62.41, FCC Part 15 A & B, NEC Article 690, C22.2 No. 107.1-01 (Sept. 2011) California Solar Initiative - Program Handbook - Appendix C, Inverter Integral 5% Meter Performance Specification, CSA TIL M-07 Issue 1-2013	UL 1741-2010, IEEE 1547-2003, IEEE 1547.1, UL 1699B-2013, ANSI/IEEE C62.41, FCC Part 15 A & B, NEC Article 690, C22.2 No. 107.1-01 (Sept. 2011) California Solar Initiative - Program Handbook - Appendix C, Inverter Integral 5% Meter Performance Specification, CSA TIL M-07 Issue 1-2013	UL 1741-2010, IEEE 1547-2003, IEEE 1547.1, UL 1699B-2013, ANSI/IEEE C62.41, FCC Part 15 A & B, NEC Article 690, C22.2 No. 107.1-01 (Sept. 2011) California Solar Initiative - Program Handbook - Appendix C, Inverter Integral 5% Meter Performance Specification, CSA TIL M-07 Issue 1-2013
Advanced grid features	Active and reactive power control, low voltage ride-through	Active and reactive power control, low voltage ride-through	Active and reactive power control, low voltage ride-through
Safety equipment	5.0-1 UNI Internal AFCI (Arc Fault Circuit Interrupter); in accordance with UL 1699B Outline of Investigation for Photovoltaic (PV) DC Arc-Fault Circuit Protection (Issue Number 2, January 14, 2013), CSA TIL M-07 issue 1-2013	6.0-1 UNI Internal AFCI (Arc Fault Circuit Interrupter); in accordance with UL 1699B Outline of Investigation for Photovoltaic (PV) DC Arc-Fault Circuit Protection (Issue Number 2, January 14, 2013), CSA TIL M-07 issue 1-2013	7.5-1 UNI Internal AFCI (Arc Fault Circuit Interrupter); in accordance with UL 1699B Outline of Investigation for Photovoltaic (PV) DC Arc-Fault Circuit Protection (Issue Number 2, January 14, 2013), CSA TIL M-07 issue 1-2013
Arc fault circuit protection	Internal GFDI (Ground Fault Detector/Interrupter); in accordance with UL 1741-2010 and NEC Art. 690	Internal diode	Internal diode
Ground fault protection	Internal; in accordance with UL 1741-2010, IEEE 1547-2003 and NEC	Output power derating / active cooling	Output power derating / active cooling
DC reverse polarity protection			
Anti-islanding			
Over temperature			

### Equipment features

**On-site module grounding**  
Decide on-site what type of grounding is required, as the device is field-programmable for either positive or negative module grounding.

**Indoor and outdoor use**  
All Fronius IG Plus V inverters have a rugged, elegant metal housing. They are UV-resistant and have corrosion protection, making them suitable for both indoor and outdoor use.

**Integrated DC disconnect**  
No external DC disconnect installation or cabling is necessary. The Fronius IG Plus Advanced comes complete with an approved, built-in, lockable and load breakable DC disconnect.

**Integrated string combiner**  
Up to six strings can be connected directly to all Fronius IG Plus Advanced inverters. The integrated holders for string fuses allow the module strings to be disconnected from one another depending on the module manufacturer's requirements.





## Solar Array Layout Calculations

The following are calculations done to determine the optimal tilt of the panels as well as the spacing between the two sections of 8 panels in series.

### Optimal Tilt

The panels will be installed to point due south (-21 degrees from angle of the roof).

Latitude of the Waterfront Neighbourhood Centre: 43.635703

Option A:

Since latitude is between 25° and 50°, use the latitude, times 0.76, plus 3.1 degrees.

$$43.635703^\circ \times 0.76 + 3.1^\circ = 36.2^\circ$$

Option B:

If your latitude is between 25° and 50°, then the best tilt angle for summer is the latitude, times 0.93, minus 21 degrees.

$$43.635703^\circ \times 0.93 - 21^\circ = 19.6^\circ$$

The best tilt angle for winter is the latitude, times 0.875, plus 19.2 degrees.

$$43.635703^\circ \times 0.875 + 19.2^\circ = 57.4^\circ$$

### Solar Array Spacing Calculations

Given the limit of a 5kW system and minimal space restrictions on the WNC roof, the spacing between panels has been determined based on most conservative conditions at 4 PM of the Winter Solstice, in accordance with the available solar window on that day, determined by the shading study. Solar angles are obtained from the National Research Council of Canada Sunrise/Sunset calculator.

Time: 4:00 PM (Daylight Savings), December 21<sup>st</sup> 2017 (Winter Solstice)

Angle of the sun at WNC: 13

Azimuth of the sun at WNC: 218.3

Panel height: 1.43 (based on 1.96m length and 36.2° recommended tilt in Option A.

$$D' = \frac{1.43}{\tan 13^\circ} = 6.19$$

$$Distance = D' * \cos(218.3^\circ - 180^\circ) = 4.86 \text{ m}$$

Therefore, the panels should be spaced at 5 m to avoid casting shade.



Waterfront  
Neighbourhood  
Centre

April 22, 2017

Formerly Harbourfront Community Centre

Green Energy Challenge 2017 - Northern Lights Solutions  
CECA/NECA University of Toronto Student Chapter  
Room GB 314, Galbraith Building  
Department of Civil Engineering  
University of Toronto  
35 St. George Street  
Toronto, ON M5S 1A4

Re: Waterfront Neighbourhood Centre - Green Energy Challenge 2017

Dear Team:

I am writing to thank you for the time and energy you have spent in preparing a NECA/CECA submission for Waterfront Neighbourhood Centre (WNC). The analysis and proposed recommendations on the building's energy use, including lighting improvements and addition of renewable sources, are well-founded with consideration of the community services provided by the building.

I appreciated working with your analysis team as you collected data for the building's energy audit. As WNC is a public Community Centre, we provide various community services that require the facilities to be open and running at specific times. The proposed addition of LED lights along with the addition of window glazing and light shelf technology will therefore, ensure lighting energy efficiency and help distribute lighting evenly across the rooms that have lower light quality. In addition, your team's astute observations and questions of the building's elements in particular the mechanical room shows an impressive grasp of the building and the occupants' needs. I eagerly await to see the final design of the rooftop solar system as well as details on implementation of lighting improvements.

I convey my enthusiastic support towards your team for the Green Energy Challenge 2017. I wish you a great success and hope to have further opportunities to work together with your team and to investigate the improvements to the building as per your proposal.

Please feel to contact me if you have any questions at 416-392-1509 oriel@waterfrontnc.ca

Sincerely,

Orielle Boothe  
Manager, Facility Operations

627 Queens Quay West, Toronto, Ontario M5V 3G3  
Tel. 416.392.1509 Fax 416.392.1512  
www.waterfrontnc.ca



**Canadian Electrical Contractors Association**  
**Association canadienne des entrepreneurs électriciens**

---

April 26, 2017

Northern Lights Solutions  
University of Toronto Student Chapter  
Canadian Electrical Contractors Association (CECA)/  
National Electrical Contractors Association (NECA)

Attention: NLS Team

Re: **ELECTRI Green Energy Challenge, Energy Retrofit of Waterfront  
Neighbourhood Centre**

Thank you for our recent meeting and the opportunity to review your proposal. The organization that you have chosen, the Waterfront Neighbourhood Centre (WNC), is very deserving of this type of assistance. I believe your effort to collaborate with the WNC far exceeds what is required for the Green Energy Challenge and has resulted in a stronger and more client-focused proposal.

Your efforts to establish NECA's first international student chapter are nothing short of remarkable. The depth of this proposal, especially with respect to envelope and mechanical system upgrades, is proof that the true focus of this proposal is improving the Waterfront Neighbourhood Centre's facility. We are proud to be associated with a group of young people that are certain to be among the future leaders of our industry.

The outreach component of your proposal has also continued to strengthen CECA's local presence. NLS volunteering at both with the WNC's After 4 program as well the earth day event proved excellent opportunities to share the benefits of sustainable electrical design. At the same time the team's revamping of the blog and regular email updates have provided us and the electrical contracting industry with better access to the great work you have been doing.

On behalf of the Canadian Electrical Contractors Association (CECA) we wish Northern Lights Solutions great success in the 2017 Electri Green Energy Challenge competition.

Yours truly,

David Mason  
President - CECA

---

Dave Mason, President, Canadian Electrical Contractors Association  
41 Maple Street, Uxbridge, Ontario L8P 1C8

Tel: 416-491-2414

Fax: 416-795-0009

 [www.ceca.org](http://www.ceca.org)

April 27, 2017

Northern Lights Solutions  
University of Toronto Student Chapter  
Canadian Electrical Contractors Association (CECA)/  
National Electrical Contractors Association (NECA)

Re: ELECTRI Green Energy Challenge, Energy Retrofit of Waterfront Neighbourhood Centre

Attention: NLS Team

Thank you for sharing your energy retrofit proposal for the Waterfront Neighbourhood Centre (WNC) at our recent meeting. Coming from a group that regularly reviews such proposals, I must say that it was very well done. We are hoping to undertake future improvements at the WNC and your work will be helpful for selecting the most appropriate measures.

From an energy perspective, there are several complexities that arise in a shared space building. Your recommendations show considerable thought for the needs of the WNC, cost-effectiveness, and feasibility constraints. Your eagerness to merge recommendations with proposed facility improvements will greatly reduce the negative impacts to the facility and should result in significant financial savings.

Your proposal is also very timely. The City's Environment and Energy Division has been considering a number of possible sustainable energy initiatives for WNC. Northern Lights Solutions' report will be of great value in helping us to develop our retrofit program. Your stakeholder engagement with WNC staff and users will also be very helpful in enabling us to work with those groups on any projects we decide to proceed with.

I want to commend Northern Lights Solutions for your efforts and wish you the best in the 2017 ELECTRI Green Energy Challenge competition. I look forward to further collaboration on this project and potentially new projects in the future.

Best wishes,

Rob Maxwell  
Manager, Toronto Renewable Energy Office  
Acting Manager, Energy and Waste Management Office  
Environment and Energy Division  
City of Toronto